

# DAV-X10

## DVD Home Theatre System

### Operating Instructions



\* 3 2 1 0 5 6 5 1 3 \* (1)



## WARNING

**To reduce the risk of fire or electric shock, do not expose this apparatus to rain or moisture.**

**Caution – The use of optical instruments with this product will increase eye hazard.**

Do not install the appliance in a confined space, such as a bookcase or built-in cabinet.

To prevent fire or shock hazard, do not place objects filled with liquids, such as vases, on the apparatus.

Batteries or batteries installed apparatus shall not be exposed to excessive heat such as sunshine, fire or the like.

## For the customers in the U.S.A

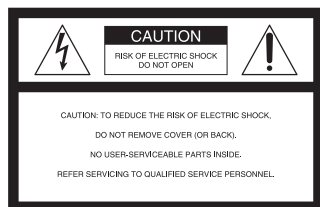

This symbol is intended to alert the user to the presence of uninsulated “dangerous voltage” within the product’s enclosure that may be of sufficient magnitude to constitute a risk of electric shock to persons.



This symbol is intended to alert the user to the presence of important operating and maintenance (servicing) instructions in the literature accompanying the appliance.

This graphical symbol is located on the bottom of the unit.

### Owner's Record

The model number is located on the bottom exterior and the serial number is located on the rear exterior. Record the serial number in the space provided below. Refer to them whenever you call upon your Sony dealer regarding this product.

Model No. DAV-X10

Serial No. \_\_\_\_\_

## WARNING

This equipment has been tested and found to comply with the limits for a Class B digital device, pursuant to Part 15 of the FCC Rules. These limits are designed to provide reasonable protection against harmful interference in a residential installation. This equipment generates, uses, and can radiate radio frequency energy and, if not installed and used in accordance with the instructions, may cause harmful interference to radio communications. However, there is no guarantee that interference will not occur in a particular installation. If this equipment does cause harmful interference to radio or television reception, which can be determined by turning the equipment off and on, the user is encouraged to try to correct the interference by one or more of the following measures:

- Reorient or relocate the receiving antenna (aerial).
- Increase the separation between the equipment and receiver.
- Connect the equipment into an outlet on a circuit different from that to which the receiver is connected.
- Consult the dealer or an experienced radio/TV technician for help.

## CAUTION

You are cautioned that any changes or modifications not expressly approved in this manual could void your authority to operate this equipment.

## Important Safety Instructions

- 1) Read these instructions.
- 2) Keep these instructions.
- 3) Heed all warnings.
- 4) Follow all instructions.
- 5) Do not use this apparatus near water.
- 6) Clean only with dry cloth.
- 7) Do not block any ventilation openings. Install in accordance with the manufacturer’s instructions.
- 8) Do not install near any heat sources such as radiators, heat registers, stoves, or other apparatus (including amplifiers) that produce heat.
- 9) Do not defeat the safety purpose of the polarized or grounding-type plug. A polarized plug has two blades with one wider than the other. A grounding type plug has two blades and a third grounding prong. The wide blade or the third prong are provided for your safety. If the provided plug does not fit into your outlet, consult an electrician for replacement of the obsolete outlet.
- 10) Protect the power cord from being walked on or pinched particularly at plugs, convenience receptacles, and the point where they exit from the apparatus.

- 11) Only use attachments/accessories specified by the manufacturer.
- 12) Use only with the cart, stand, tripod, bracket, or table specified by the manufacturer, or sold with the apparatus. When a cart is used, use caution when moving the cart/apparatus combination to avoid injury from tip-over.



- 13) Unplug this apparatus during lightning storms or when unused for long periods of time.
- 14) Refer all servicing to qualified service personnel. Servicing is required when the apparatus has been damaged in any way, such as power-supply cord or plug is damaged, liquid has been spilled or objects have fallen into the apparatus, the apparatus has been exposed to rain or moisture, does not operate normally, or has been dropped.

**Note to CATV system installer:**

This reminder is provided to call the CATV system installer's attention to Article 820-40 of the NEC that provides guidelines for proper grounding and, in particular, specifies that the cable ground shall be connected to the grounding system of the building, as close to the point of cable entry as practical.

## Precautions

### Safety

- The unit is not disconnected from the AC power source (mains) as long as it is connected to the wall outlet (mains), even if the unit itself has been turned off.
- Install this system so that the AC power cord (mains lead) can be unplugged from the wall socket immediately in the event of trouble.
- Handle the top panel of the unit with care as it is made of tempered glass.

## Welcome!

Thank you for purchasing Sony DVD Home Theatre System. Before operating this system, please read this manual thoroughly and retain it for future reference.

# Table of Contents

Welcome! .....	3	Turning off the System with the TV.....	40
About This Manual .....	6	(System Power Off)	
This System Can Play the Following Discs .....	6	Enjoying STB (Set Top Box) Digital Sound or Digital Satellite Receiver Sound from the System .....	41
<b>Getting Started – BASIC –</b>		(STB SYNCHRO)	
<b>Step 1: Connecting the System and   TV .....</b>	<b>10</b>	<b>Various Functions for Playing Discs</b>	
<b>Step 2: Installing the Speakers....</b>	<b>16</b>	Searching for a Particular Point on a Disc.....	43
<b>Step 3: Performing the Quick   Setup .....</b>	<b>18</b>	(Scan, Slow-motion Play, Freeze Frame)	
<b>Getting Started</b>		Searching for a Title/Chapter/Track/ Scene, etc.....	44
<b>– ADVANCED –</b>		Searching by Scene.....	45
TV Hookup (Advanced) .....	20	(Picture Navigation)	
Other Component Hookup .....	25	Resuming Playback from the Point Where You Stopped the Disc.....	46
<b>Basic Operations</b>		(Resume Play)	
<b>Playing Discs.....</b>	<b>28</b>	Creating Your Own Program.....	47
<b>Enjoying the Radio or Other   Components .....</b>	<b>30</b>	(Program Play)	
<b>Enjoying TV or VCR Sound from the   speaker system .....</b>	<b>31</b>	Playing in Random Order .....	48
<b>Selecting the Movie or Music   Mode .....</b>	<b>31</b>	(Shuffle Play)	
<b>Sound Adjustments</b>		Playing Repeatedly .....	49
Enjoying Surround Sound by Using Sound Field .....	32	(Repeat Play)	
Adjusting the Bass Level and Treble Level .....	33	Using the DVD's Menu .....	50
Enjoying the Sound at Low Volume.....	34	Changing the Sound .....	51
(NIGHT MODE)		Selecting [ORIGINAL] or [PLAY LIST] on a DVD-R/DVD-RW .....	52
<b>Using the HDMI CONTROL Function for 'BRAVIA' Theatre Sync</b>		Changing the Display Mode.....	53
Preparing for the HDMI CONTROL function .....	36	(INFORMATION MODE)	
Watching DVD by a Single Button Press.....	38	Viewing Information About the Disc ...	53
(One-Touch Play)		Changing the Angles .....	55
Enjoying the TV Sound from the Speakers in this System.....	39	Displaying the Subtitles.....	56
(System Audio Control)		Adjusting the Delay Between the Picture and Sound .....	56
		(A/V SYNC)	
		Selecting a Playback Layer for a Super Audio CD .....	57
		About MP3 Audio Tracks and JPEG Image Files .....	57
		Playing DATA CDs or DATA DVDs with MP3 Audio Tracks and JPEG Image Files .....	59

Playing Audio Tracks and Images as a Slide Show with Sound.....	61
Playing VIDEO CDs with PBC Functions (Ver.2.0).....	63
(PBC Playback)	

## **Tuner Functions**

Presetting Radio Stations .....	64
Listening to the Radio .....	65

## **Other Operations**

Controlling the TV with the Supplied Remote .....	67
Enjoying Multiplex Broadcast Sound .....	69
(DUAL MONO)	
Using the Sleep Timer .....	69
Changing the Brightness of the Front Panel Display .....	70
Changing the Display Appearance of the Soft-touch Buttons .....	70
(ILLUMINATION MODE)	
Using the DIGITAL MEDIA PORT Adapter .....	71

## **Advanced Settings and Adjustments**







Locking Discs .....	72
(CUSTOM PARENTAL CONTROL, PARENTAL CONTROL)	
Calibrating the Appropriate Settings Automatically .....	75
(AUTO CALIBRATION)	
Using the Setup Display.....	78
Setting the Display or Sound Track Language .....	79
[LANGUAGE SETUP]	
Settings for the Display .....	80
[SCREEN SETUP]	
Custom Settings .....	82
[CUSTOM SETUP]	
Returning to the Default Settings.....	83

## **Additional Information**

Precautions.....	84
Notes about the Discs .....	85
Troubleshooting .....	86
Self-diagnosis Function .....	89
(When letters/numbers appear in the display)	
Specifications.....	90
Glossary .....	91
Language Code List.....	95
Index to Parts and Controls .....	96
Guide to the Control Menu Display ...	100
DVD Setup Display List.....	103
System Menu List .....	104
Tuner Menu List .....	104
Index .....	105







## About This Manual

- The instructions in this manual describe the controls on the remote. You can also use the controls on the unit if they have the same or similar names as those on the remote.
- “DVD” may be used as a general term for DVD VIDEOS, DVD+RWs/DVD+Rs, and DVD-RWs/DVD-Rs.
- The following symbols are used in this manual.

Symbol	Meaning
	Functions available for DVD VIDEOS, DVD-Rs/DVD-RWs in video mode, and DVD+Rs/DVD+RWs
	Functions available for DVD-Rs/DVD-RWs in VR (Video Recording) mode
	Functions available for VIDEO CDs (including Super VCDs or CD-Rs/CD-RWs in VIDEO CD format or Super VCD format)
	Functions available for Super Audio CDs
	Functions available for music CDs or CD-Rs/CD-RWs in music CD format
	Functions available for DATA CDs (CD-ROMs/CD-Rs/CD-RWs) containing MP3* audio tracks, JPEG image files
	Functions available for DATA DVDs (DVD-ROMs/DVD-Rs/DVD-RWs/DVD+Rs/DVD+RWs) containing MP3* audio tracks, JPEG image files

\* MP3 (MPEG1 Audio Layer 3) is a standard format defined by ISO/MPEG which compresses audio data.

## This System Can Play the Following Discs

Format of discs	Disc logo
DVD VIDEO	
DVD-RW/ DVD-R	
DVD+RW/ DVD+R	
Super Audio CD	 SUPER AUDIO CD
VIDEO CD (Ver. 1.1 and 2.0 discs)/ Audio CD	
CD-RW/CD-R (audio data) (MP3 files) (JPEG files)	 

“DVD+RW,” “DVD-RW,” “DVD+R,”  
“DVD VIDEO,” and the “CD” logos are trademarks.

---

## Note about CDs/DVDs

The system can play CD-ROMs/CD-Rs/CD-RWs recorded in the following formats:

- audio CD format
- VIDEO CD format
- MP3 audio tracks, JPEG image files of format conforming to ISO 9660 Level 1/Level 2, or its extended format, Joliet

The system can play DVD-ROMs/DVD+RWs/DVD-RWs/DVD+Rs/DVD-Rs recorded in the following formats:

- MP3 audio tracks, JPEG image files of format conforming to UDF (Universal Disk Format)

---

## Example of discs that the system cannot play

The system cannot play the following discs:

- CD-ROMs/CD-Rs/CD-RWs other than those recorded in the formats listed on page 6
- CD-ROMs recorded in PHOTO CD format
- Data part of CD-Extras
- DVD Audios
- DATA DVDs that do not contain MP3 audio tracks or JPEG image files
- DVD-RAMs

Also, the system cannot play the following discs:

- A DVD VIDEO with a different region code (page 8, 93)
- A disc that has a non-standard shape (e.g., card, heart)
- A disc with paper or stickers on it
- A disc that has the adhesive of cellophane tape or a sticker still left on it

## Notes about CD-R/CD-RW/DVD-R/DVD-RW/DVD+R/DVD+RW

In some cases, CD-R/CD-RW/DVD-R/DVD-RW/DVD+R/DVD+RW cannot be played on this system due to the recording quality or physical condition of the disc, or the characteristics of the recording device and authoring software.

The disc will not play if it has not been correctly finalized. For more information, see the operating instructions for the recording device. Note that some playback functions may not work with some DVD+Rs/DVD+RWs, even if they have been correctly finalized. In this case, view the disc by normal playback. Also some DATA CDs/DATA DVDs created in Packet Write format cannot be played.

## Music discs encoded with copyright protection technologies

This product is designed to play back discs that conform to the Compact Disc (CD) standard. Recently, various music discs encoded with copyright protection technologies are marketed by some record companies. Please be aware that among those discs, there are some that do not conform to the CD standard and may not be playable by this product.

## Note on DualDiscs

A DualDisc is a two sided disc product which mates DVD recorded material on one side with digital audio material on the other side.

However, since the audio material side does not conform to the Compact Disc (CD) standard, playback on this product is not guaranteed.

---

## About Multi Session CD

- This system can play Multi Session CDs when an MP3 audio track is contained in the first session. Any subsequent MP3 audio tracks recorded in later sessions can also be played back.
- This system can play Multi Session CDs when a JPEG image file is contained in the first session. Any subsequent JPEG image files

recorded in later sessions can also be played back.

- If audio tracks and images in music CD format or VIDEO CD format are recorded in the first session, only the first session will be played back.

---

## Region code

Your system has a region code printed on the rear of the unit and will only play DVDs labeled with the same region code.

DVD VIDEOS labeled  will also play on this system.

If you try to play any other DVD VIDEO, the message [Playback prohibited by area limitations.] will appear on the TV screen.

Depending on the DVD VIDEO, no region code indication may be given even though playing the DVD VIDEO is prohibited by area restrictions.

---

## Note on playback operations of DVDs and VIDEO CDs

Some playback operations of DVDs and VIDEO CDs may be intentionally set by software producers. Since this system plays DVDs and VIDEO CDs according to the disc contents the software producers designed, some playback features may not be available. Also, refer to the instructions supplied with the DVDs or VIDEO CDs.

---

## Copyrights

This product incorporates copyright protection technology that is protected by U.S. patents and other intellectual property rights. Use of this copyright protection technology must be authorized by Macrovision, and is intended for home and other limited viewing uses only unless otherwise authorized by Macrovision. Reverse engineering or disassembly is prohibited.

This system incorporates with Dolby\* Digital and Dolby Pro Logic (II) adaptive matrix surround decoder and the DTS\*\* Digital Surround System.

This system perfectly decodes 5.1 channel signal, but you cannot add other commercially available surround speakers.

- \* Manufactured under license from Dolby Laboratories.  
“Dolby”, “Pro Logic”, and the double-D symbol are trademarks of Dolby Laboratories.
- \*\* Manufactured under license from DTS, Inc. “DTS” and “DTS Digital Surround” are registered trademarks of DTS, Inc.



### Supplied items

- Front Speakers (2)
- Subwoofer (1)
- AM loop antenna (aerial) (1)
- FM wire antenna (aerial) (1)
- Speaker cord (1)
- Video cord (1)
- Remote Commander (remote) (1)
- R6 (size AA) batteries (2)
- Calibration mic (1)
- Operating Instructions
- Quick Start Guide (card) (1)
- Bluetooth adapter (TDM-BT1) (1)

### Inserting batteries into the remote

You can control the system using the supplied remote. Insert two R6 (size AA) batteries by matching the ⊕ and ⊖ ends on the batteries inside the compartment. When using the remote, point it at the remote sensor  on the unit.

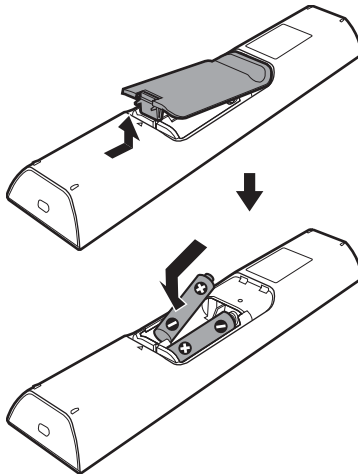

#### Note

- Do not leave the remote in an extremely hot or humid place.
- Do not use a new battery with an old one.
- Do not drop any foreign object into the remote casing, particularly when replacing the batteries.
- Do not expose the remote sensor to direct light from the sun or lighting apparatus. Doing so may cause a malfunction.
- If you do not intend to use the remote for an extended period of time, remove the batteries to avoid possible damage from battery leakage and corrosion.

## Step 1: Connecting the System and TV

This hookup is the basic connection of the unit to the speakers and TV. For other TV connections, see page 20. For other component connection, see page 25.

To accept progressive signals, see page 23.

To obtain the best possible front surround sound, install the speakers in the proper position (page 16), and perform [AUTO CALIBRATION] (page 75).

Refer to the connection diagram below, and read the additional information from ① to ④ on the following pages.

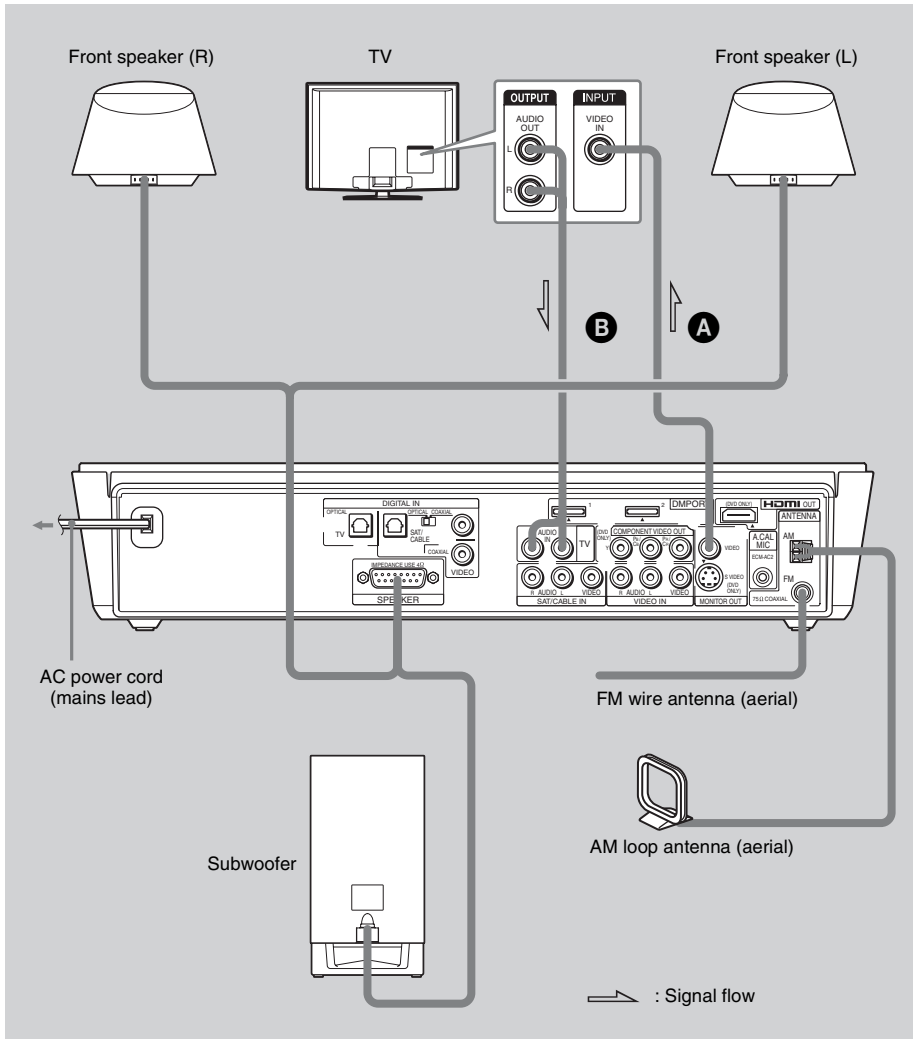

**Note**

- Be careful when carrying or placing the unit and subwoofer because they are so heavy.

## ① Connecting the Speakers

### Required cords

You can connect the unit and speakers with this one cord.

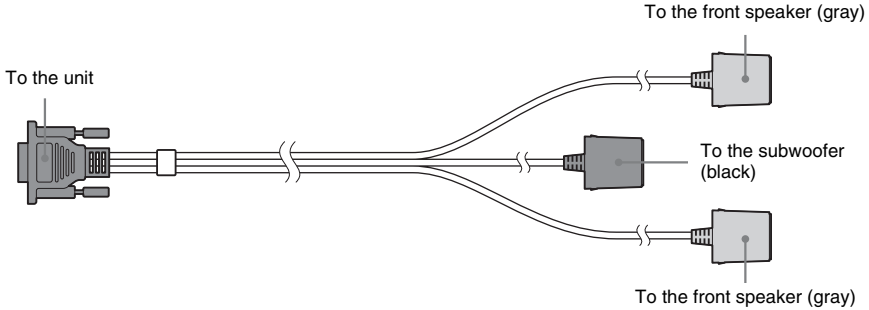
**Note**

- Do not connect any speakers other than those supplied with this system.

**Tip**

- By connecting an extension cord (not supplied) to the respective jack(s) of the speaker cord, you can extend the length of the cord.

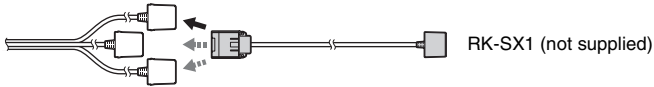

### To connect the speakers

**Note**

- Spread a cloth on the floor to avoid damaging the floor and the speakers.

#### 1 Connect the speaker cord to the unit.

Secure the jack by tightening the two screws.

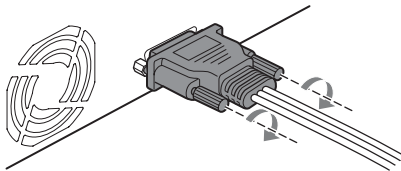

## 2 Turn the speaker upside down, and connect the speaker jack to the front speaker.

Connect the speaker jack (LEFT) to the left speaker and the speaker jack (RIGHT) to the right speaker.

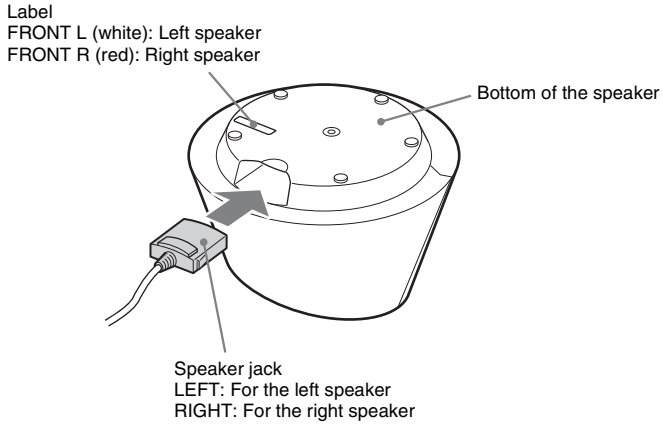

### Note

- Exercise care to avoid scratching on the top of the speaker.
- If the speakers should cause the TV screen to have color irregularity, turn off the TV then turn it on after 15 to 30 minutes. If color irregularity should persist, place the speakers further away from the set.

## 3 Connect the speaker jack (WOOFER) to the subwoofer.

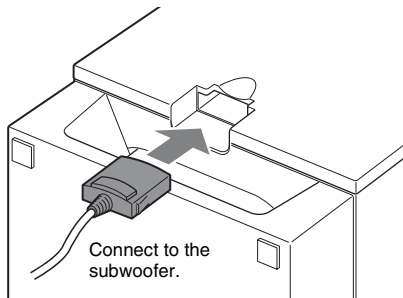

**Note on handling the subwoofer**

- Do not place your hand into the slit of the subwoofer when lifting it. The speaker driver may be damaged. When lifting, hold the bottom of the subwoofer.

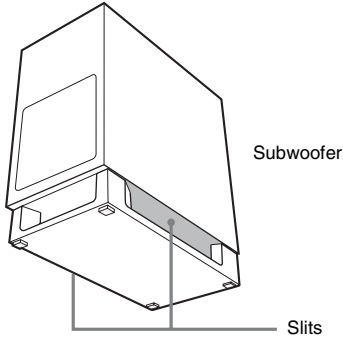
**Note**

- When cleaning, use a soft cloth such as a cleaning cloth for glasses.
- Do not use any type of abrasive pad, scouring powder, or solvent such as alcohol or benzene.
- Do not connect the WOOFER jack to either front speaker, or the LEFT or RIGHT jacks to the subwoofer.

**Tip**

- When you connect the speaker jack to the subwoofer, place it in the horizontal position.

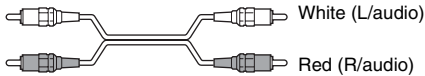
**② Connecting the TV****Required cords****A Video cord****B Audio cord (not supplied)****Note**

- When connecting the jack, insert the plug into the jack as far as it will go.

Example

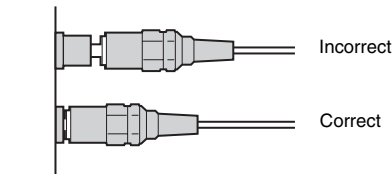

### ③ Connecting the Antenna (Aerial)

#### To connect the AM loop antenna (aerial)

The shape and the length of the antenna (aerial) is designed to receive AM signals. Do not dismantle or roll up the antenna (aerial).

- 1 Remove only the loop part from the plastic stand.
- 2 Set up the AM loop antenna (aerial).

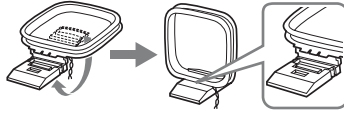

#### 3 Connect the cords to the AM terminals.

Cord (A) or cord (B) can be connected to either terminal.

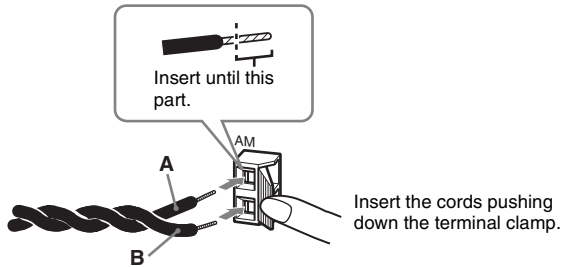

#### Note

- Do not place the AM loop antenna (aerial) near the unit or other AV equipment, as noise may result.

#### Tip

- Adjust the direction of the AM loop antenna (aerial) for best AM broadcast sound.

#### 4 Make sure the AM loop antenna (aerial) is connected firmly by pulling softly.

#### To connect the FM wire antenna (aerial)

Connect the FM wire antenna (aerial) to the FM 75  $\Omega$  COAXIAL jack.

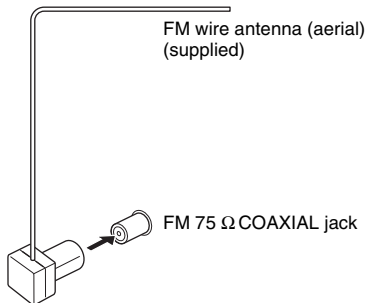

**Note**

- Be sure to fully extend the FM wire antenna (aerial).
- After connecting the FM wire antenna (aerial), keep it as horizontal as possible.

**Tip**

- If you have poor FM reception, use a 75-ohm coaxial cable (not supplied) to connect the unit to an outdoor FM antenna (aerial) as shown below.

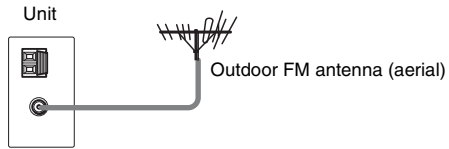

---

#### ④ Connecting the AC power cord (mains lead)

Before connecting the AC power cord (mains lead) of this unit to a wall outlet (mains), connect all the speakers to the unit.

## Step 2: Installing the Speakers

For the best possible front surround sound, position the speakers as illustrated below.

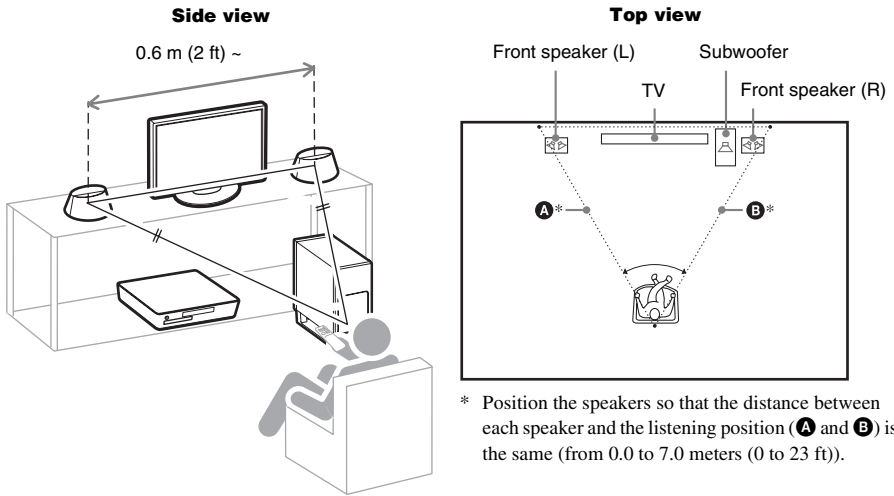

### Notes about positioning the front speakers

For best results, observe the following:

- Place both front speakers the same distance apart as they are from the listening position (to form an isosceles triangle).
- The front speakers should be placed at least 0.6 m (2 ft) apart.
- The front speakers should be placed at ear level in the listening position.
- Place the front speakers forward of the TV. Make sure there are no reflecting obstacles in front of the speakers.
- Both front speakers should be pointed straight forward. Do not place the speakers at an angle.

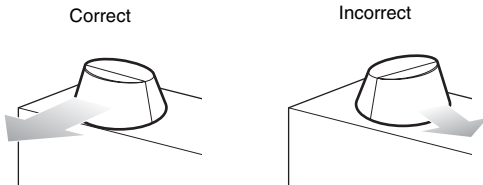



- Do not leave a space in front of the front speakers when placed on a table or rack, etc., as reflection may occur.

Side view

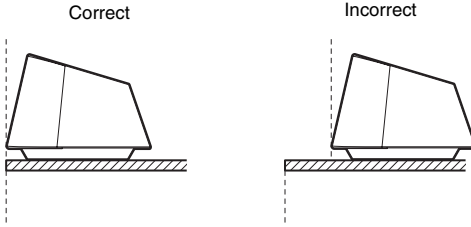

**Tip**

- You can attach the front speaker to the speaker stand (not supplied), or the wall mounting bracket (not supplied).

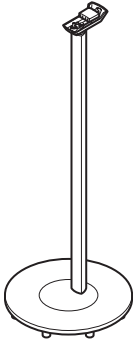

WS-X10FB (not supplied)

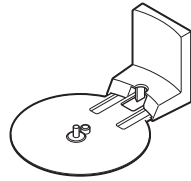

WS-X10W (not supplied)

## Step 3: Performing the Quick Setup

Follow the steps below to make the minimum number of basic adjustments for using the system.

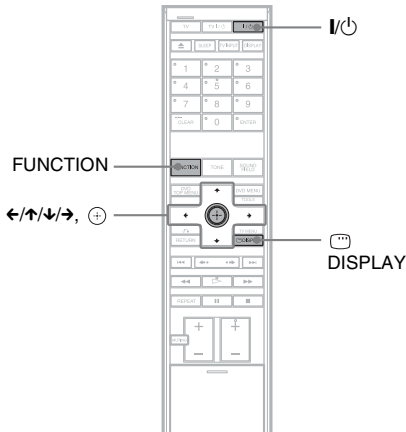

- 1 Turn on the TV.**
- 2 Press I/⏻.**
- 3 Press FUNCTION repeatedly until "DVD" appears in the front panel display.**
- 4 Switch the input selector on your TV so that the signal from the system appears on the TV screen.**  
[Press [ENTER] to run QUICK SETUP.] appears at the bottom of the screen. If this message does not appear, display the Quick Setup and perform again (page 19).
- 5 Press ⊕ without inserting a disc.**  
The Setup Display for selecting the language used in the on-screen display appears.

LANGUAGE SETUP	
OSD:	ENGLISH
MENU:	ENGLISH
AUDIO:	FRENCH
SUBTITLE:	SPANISH
	PORTUGUESE

- 6 Press ↑/↓ to select a language.**  
The system displays the menu and subtitles in the selected language.
- 7 Press ⊕.**  
The Setup Display for selecting the aspect ratio of the TV to be connected appears.

SCREEN SETUP	
TV TYPE:	16:9
HDMI RESOLUTION:	16:9
Y/CbCr/RGB (HDMI):	4:3 LETTER BOX
SCREEN SAVER:	4:3 PAN SCAN
BACKGROUND:	JACKET PICTURE
BLACK LEVEL:	ON
BLACK LEVEL (COMPONENT OUT):	OFF
4:3 OUTPUT:	FULL

- 8 Press ↑/↓ to select the setting that matches your TV type.**  
  - If you have a wide-screen TV or a 4:3 standard TV with a wide-screen mode [16:9] (page 80)
  - If you have a 4:3 standard TV [4:3 LETTER BOX] or [4:3 PAN SCAN] (page 80)
- 9 Press ⊕.**  
The [AUTO CALIBRATION] display appears.

AUTO CALIBRATION	
Connect calibration mic. Start measurement?	
YES	
NO	

- 10 Connect the calibration mic to the A.CAL MIC jack on the rear panel, and set it up at the ear level using a tripod, etc. (not supplied).**  
The front of each speaker should face the calibration mic, and there should be no obstruction between the speakers and the calibration mic.

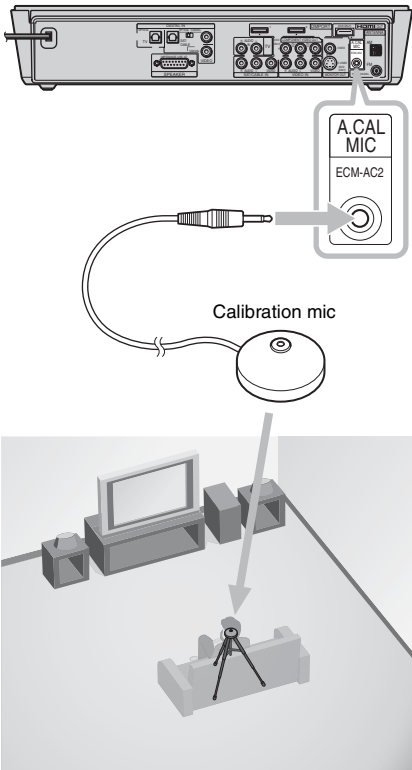

- 11** Press  $\uparrow/\downarrow$  to select [YES], then press  $\oplus$ .  
[AUTO CALIBRATION] starts. Be quiet during the measurement.

**Note**

- Loud test sound is output when [AUTO CALIBRATION] starts. You cannot turn the volume down. Give consideration to children and neighbors.
- Avoid being in the measurement area and making noise during the measurement (which takes about 1 minute), as it may interfere with measurement.

- 12** Unplug the calibration mic and press  $\leftarrow$  to select [YES].  
 $\rightarrow$  to select [YES].

Quick Setup is finished. All connections and setup operations are complete.

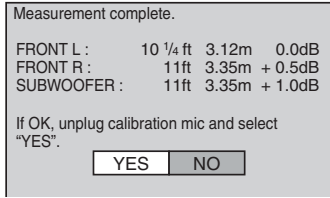
**Note**

- The environment of the room in which the system is installed may affect measurements.
- If measurement fails, follow the message then retry [AUTO CALIBRATION].

**To quit the Quick Setup**

Press  $\square$  DISPLAY in any Step.

**Tip**

- If you change the position of the speakers, reset the speaker settings. See "Calibrating the Appropriate Settings Automatically" (page 75).
- If you want to change any of the settings, see "Using the Setup Display" (page 78).
- If there is no sound from the speakers, check the speaker connection.

**To recall the Quick Setup display**

- 1** Press  $\square$  DISPLAY when the system is in stop mode.

The Control Menu display appears.

- 2** Press  $\uparrow/\downarrow$  to select  [SETUP], then press  $\oplus$ .

The options for [SETUP] appear.

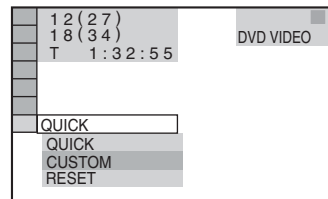

- 3** Press  $\uparrow/\downarrow$  to select [QUICK], then press  $\oplus$ .  
The Quick Setup display appears.

## TV Hookup (Advanced)

Select a hookup suitable for the jacks on your TV.

### Connecting the video/audio/HDMI\* cords

Sends a played back DVD image to a TV (video connection), and sends a TV sound to the system (audio connection).

For the video connection, check the jacks of your TV, and choose connection method **A**, **B**, **C**, or **D**. Picture quality improves in order from **A** (standard) to **D** (HDMI).

For the audio connection, connect the audio cords (**E**).

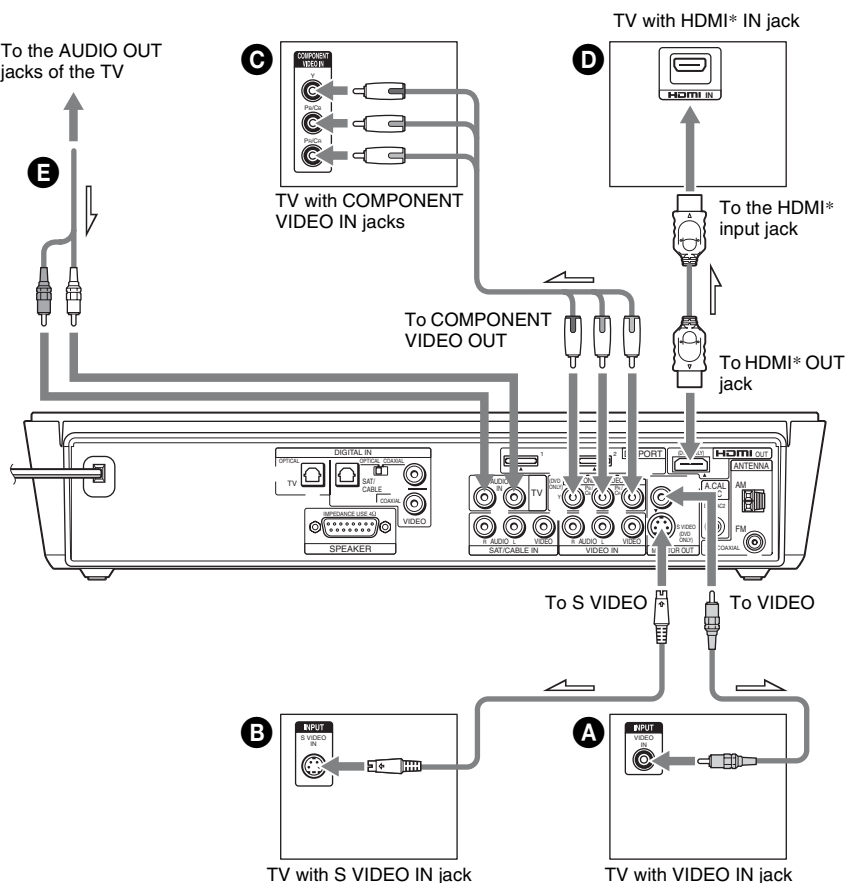

↗ : Signal flow

**Note**

- The video signals of connection method **B** (S VIDEO), **C** (COMPONENT VIDEO), and **D** (HDMI) are output, only when the function is set to “DVD.”
- \* HDMI (high-definition multimedia interface)  
The system incorporates High-Definition Multimedia Interface (HDMI™) technology.  
HDMI, the HDMI logo and High-Definition Multimedia Interface are trademarks or registered trademarks of HDMI Licensing LLC.

**A To connect to a TV with the VIDEO IN jack**

Connect the video cord.

**Note**

- The video signal that is input from the VIDEO (VIDEO IN or SAT/CABLE IN) jack is output from the VIDEO (MONITOR OUT) jack only.

**B To connect to a TV with the S VIDEO IN jack**

Connect an S video cord (not supplied).

**Note**

- The video signal is output from the S VIDEO OUT jack, only when the function is set to “DVD.”

**C To connect to a TV with the COMPONENT VIDEO IN jacks**

Connect a component video cord (not supplied). To use the COMPONENT VIDEO OUT jacks (Y, Pb/Cb, Pr/Cr) instead of the video jacks, your TV monitor must be equipped with COMPONENT VIDEO IN jacks (Y, Pb/Cb, Pr/Cr). If your TV accepts progressive format signals, you must use this connection and set the output channel of the system to progressive format (page 23).

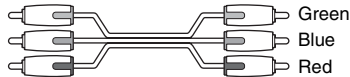
**Note**

- The video signal is output from the COMPONENT VIDEO OUT jacks, only when the function is set to “DVD.”

**D To connect to a TV with the HDMI (high-definition multimedia interface)/DVI (digital visual interface) input jack**

Use a certified HDMI (high-definition multimedia interface) cable (not supplied) to enjoy high quality digital picture and sound through the HDMI OUT (high-definition multimedia interface out) jack. Note that Super Audio CD sound is not output from the HDMI OUT (high-definition multimedia interface out) jack.

**Note**

- The video signal is output from the HDMI OUT jack, only when the function is set to “DVD.”
- Insert the HDMI cable in the jack oriented correctly as the HDMI cable connector is polar.

### To connect to a TV with DVI (digital visual interface) input

Use an HDMI (high-definition multimedia interface)-DVI (digital visual interface) converter cord (not supplied) with an HDMI (high-definition multimedia interface)-DVI (digital visual interface) adaptor (not supplied). The DVI (digital visual interface) jack will not accept any audio signals. Furthermore, you cannot connect the HDMI OUT (high-definition multimedia interface out) jack to DVI (digital visual interface) jacks that are not HDCP (high-bandwidth digital content protection) compliant (e.g., DVI (digital visual interface) jacks on the computer displays).

### **E** To connect a TV using the audio cords (not supplied)

Connect the unit and the TV using the audio cords.

You can enjoy the TV sound from all speakers in this system.

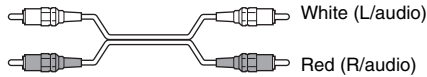

---

### Connecting the TV with the digital optical cord (not supplied)

A TV with a digital optical out jack (TV with built-in digital satellite receiver, etc.) can be connected to the TV (DIGITAL IN OPTICAL) jack instead of the TV (AUDIO IN) jacks.

The system can accept both the digital and analog signals. Digital signals have priority over analog signals. If the digital signal ceases, the analog signal will be processed after a few seconds.

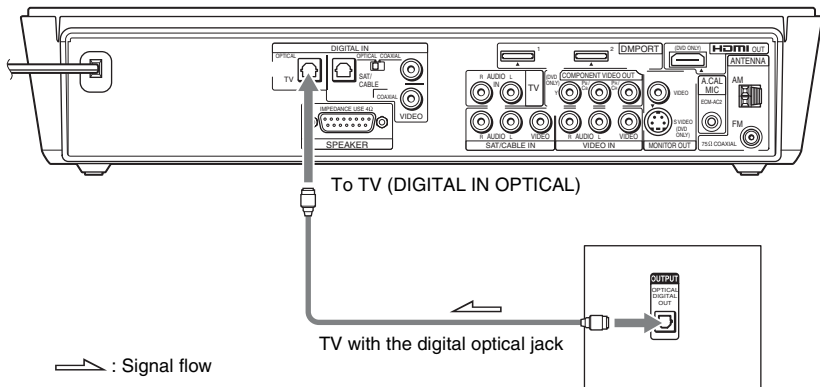

#### **Tip**

- When connecting the digital optical cord, insert the connector until it clicks.

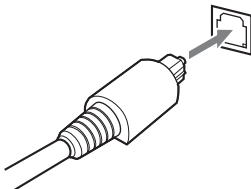

## When connecting to a standard 4:3 screen TV

Depending on the disc, the image may not fit your TV screen.  
To change the aspect ratio, see page 80.

## Does your TV accept progressive signals?

Progressive is a TV image display method which reduces flickering, and sharpens the image.  
To display using this method, you need to connect to a TV that accepts progressive signals.

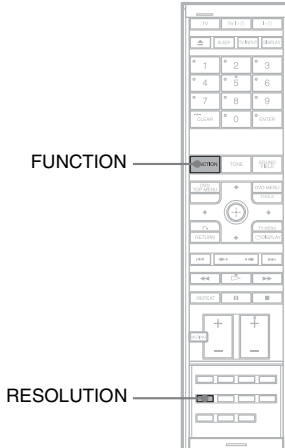

With the cover opened.

“PROGRESSIVE” lights up in the front panel display when the system outputs progressive signals.

- 1** Press **FUNCTION** repeatedly to select “DVD.”
- 2** Press **RESOLUTION**.

Each time you press **RESOLUTION**, the display changes as follows:

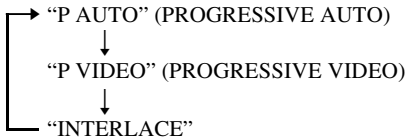

### ■ “P AUTO” (PROGRESSIVE AUTO)

Select this setting when:

- your TV accepts progressive signals, and,
- the TV is connected to the COMPONENT VIDEO OUT jacks.

Normally select this if the above conditions are met. This automatically detects the software type, and selects the appropriate conversion method.

Note that the picture will not be clear or no picture will appear if you select these settings when either of the above conditions are not met.

### ■ “P VIDEO” (PROGRESSIVE VIDEO)

Select this setting when:

- your TV accepts progressive signals, and,
  - the TV is connected to the COMPONENT VIDEO OUT jacks, and,
  - you want to fix the conversion method to PROGRESSIVE VIDEO for video based software.
- Select this if the image is not clear when you select PROGRESSIVE AUTO.

Note that the picture will not be clear or no picture will appear if you select these settings when either of the above conditions are not met.

### ■ “INTERLACE”

Select this setting when:

- your TV does not accept progressive signals, or,
- your TV is connected to jacks other than the COMPONENT VIDEO OUT jacks (MONITOR OUT (S VIDEO/VIDEO)).

You cannot select INTERLACE while “HDMI” lights up in the front panel display.

## **About DVD software types and the conversion method**

DVD software can be divided into 2 types: film based software and video based software.

Video based software is derived from TV, such as dramas and sit-coms, and displays images at 30 frames/60 fields per second. Film based software is derived from film and displays images at 24 frames per second. Some DVD software contains both video and film.

In order for these images to appear natural on your screen when output in progressive format, the progressive signals need to be converted to match the type of DVD software that you are watching.

#### **Note**

- When you play video based software in progressive signal format, sections of some types of images may appear unnatural due to the conversion process when output through the COMPONENT VIDEO OUT jacks.
- Even though you set to “PROGRESSIVE AUTO” or “PROGRESSIVE VIDEO,” images from the MONITOR OUT (S VIDEO or VIDEO) jack are unaffected as they are output in the interlace format.
- For details on changing the HDMI resolution, see “Settings for the Display” (page 80).



# Other Component Hookup

You can enjoy other component through the speakers of this system by connecting the VIDEO/AUDIO OUT jacks of another component.

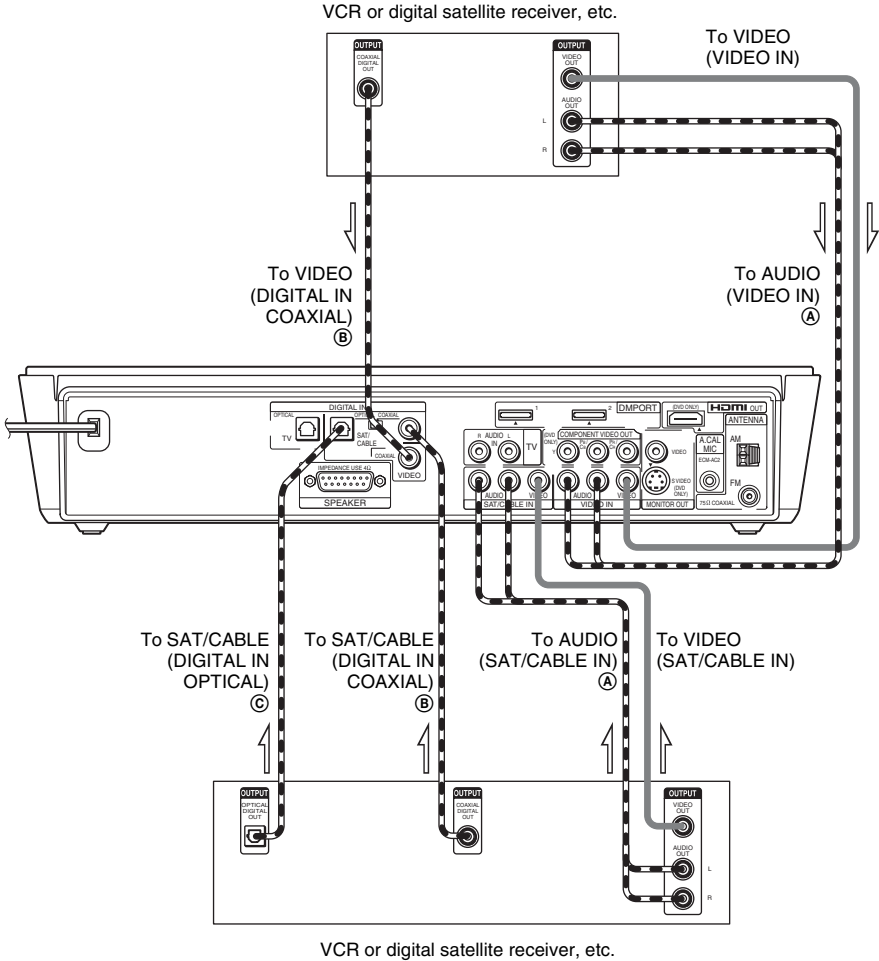

Video signal: Video connection  
 Audio signal: Audio connection (A), (B), (C)

: Signal flow

---

## Connecting the video cord

### To connect the VIDEO OUT jack of another component to the VIDEO IN or SAT/CABLE IN jack of this unit

Connect a VCR or other component to the VIDEO IN or SAT/CABLE IN jack using a video/audio cord (not supplied).

When connecting a cord, be sure to match the color-coded sleeve to the appropriate component jack.

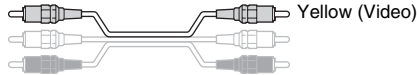

#### Note

- The video signal that is input from the VIDEO IN or SAT/CABLE IN jack is output from the VIDEO (MONITOR OUT) jack only.

---

## Connecting the audio cords

The quality of the audio increases from (A) to (B), (C).

### (A) To connect the AUDIO OUT jacks of other component to the AUDIO IN jacks of this unit

Connect a VCR or other component to the AUDIO IN jacks using an video/audio cord (not supplied). When connecting the cords, be sure to match the color-coded sleeves to the appropriate component jacks.

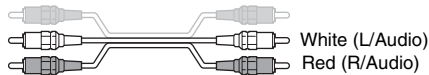

### (B) To connect the COAXIAL DIGITAL OUT jack of a component to the DIGITAL IN COAXIAL jack of this unit

Connect the component to the DIGITAL IN COAXIAL jack using a coaxial digital cord (not supplied).



### (C) To connect the OPTICAL DIGITAL OUT jack of a component to the DIGITAL IN OPTICAL jack of this unit

Connect the component to the DIGITAL IN OPTICAL jack using a optical digital cord (not supplied).



#### Note

- When you connect to the SAT/CABLE DIGITAL IN OPTICAL or COAXIAL jack, set the switch on the rear panel accordingly.

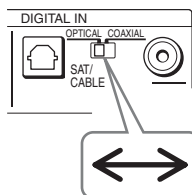

## If you connect a digital satellite receiver with a DIGITAL OUT (COAXIAL or OPTICAL) jack

The digital satellite receiver can be connected to the SAT/CABLE DIGITAL IN OPTICAL or COAXIAL or VIDEO DIGITAL IN COAXIAL jack instead of the SAT/CABLE IN (AUDIO) or VIDEO IN (AUDIO) jacks of the unit.

The system can accept both the digital and analog signals. Digital signals have priority over analog signals. If the digital signal ceases, the analog signal will be processed after 2 seconds.

## If you connect a digital satellite receiver without a DIGITAL OUT jack

Connect the digital satellite receiver to the SAT/CABLE IN (AUDIO) or VIDEO IN (AUDIO) jacks only of the unit.

### Note

- Be sure to make connections securely to avoid hum and noise.

## To connect the DIGITAL MEDIA PORT adapter

Connect the supplied DIGITAL MEDIA PORT adapter (TDM-BT1) to the DMPORT1 jack on the unit or other DIGITAL MEDIA PORT adapter to the DMPORT2 jack on the unit. For details of the DIGITAL MEDIA PORT adapter, see “Using the DIGITAL MEDIA PORT Adapter” (page 71).

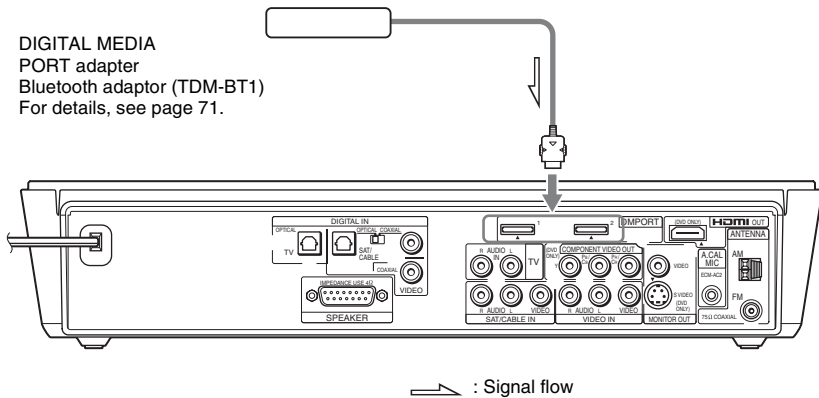

### Tip

- When listening to MP3 or other compressed music using a portable audio source, you can enhance the sound. Connect the DIGITAL MEDIA PORT adapter. Press FUNCTION to select “DMPORT1” or “DMPORT2.” Press SOUND FIELD repeatedly until “AUTO” or “P.AUDIO” appears in the front panel display. To cancel, select “2CH STEREO.”
- Insert the DIGITAL MEDIA PORT adapter in the jack oriented correctly as the connector of the DIGITAL MEDIA PORT adapter is polar.

## Basic Operations

## Playing Discs

DVD-V   DVD-VR   VIDEO CD   Super Audio CD   CD

DATA-CD   DATA DVD

Depending on the DVD VIDEO or VIDEO CD, some operations may be different or restricted. Refer to the operation details supplied with your disc.

## Soft-touch buttons

▲   ►   ■   ◀▶   FUNCTION   -   VOLUME   +

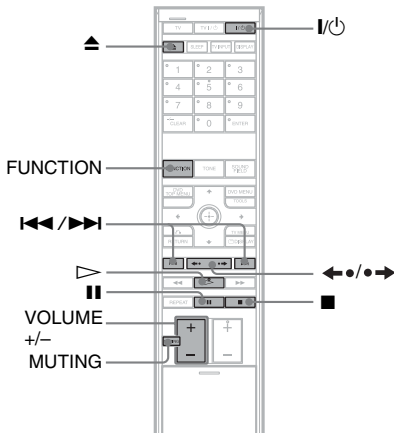
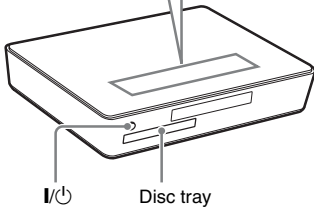

## Note

- These buttons work by touching lightly. Do not press them strongly.
- Do not place objects on the top of the unit. Doing so may activate the soft-touch buttons.

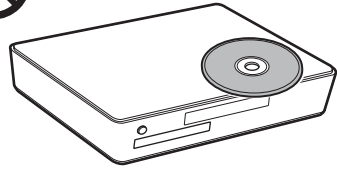

## Tip

- These buttons function when the soft-touch buttons are lit up.
- You can change the way the soft-touch buttons appear when they are touched (page 70).

- 1 Turn on your TV.
- 2 Switch the input selector on the TV to this system.
- 3 Press I/O.

The system turns on.

Unless the system is set to “DVD,” press FUNCTION to select “DVD.”

- 4 Press ▲.
- 5 Load a disc.

Place one disc on the tray, and then press ▲.

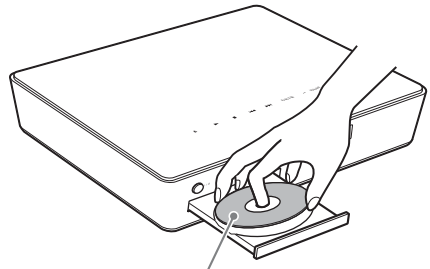

With the playback side facing down

## Note

- When you play an 8 cm disc, place it on the inner circle of the tray. Be careful that the disc is not skewed on the inner circle of the tray.
- Do not forcibly press the disc tray closed with your finger, as this may cause malfunction.
- Do not place more than one disc on the tray.

## 6 Press .

The system starts playback (continuous play).

Adjust the volume on the remote or touch VOLUME +/- (soft-touch button) on the unit.

The volume level appears on the TV screen and in the front panel display.



### Tip

- You can change the speed at which the volume is turned up and down.
  - To turn the volume up/down quickly:
    - Press and hold the VOLUME +/- on the remote.
    - Touch the VOLUME +/- (soft-touch button) on the unit, when “VOLUME XX” (X is a number) appears, touch and hold the VOLUME +/-.
  - To set the volume up/down precisely:
    - Press the VOLUME +/- briefly on the remote.
    - Touch briefly VOLUME +/- (soft-touch button) on the unit.
- When you connect the system and TV with the HDMI cable, you can operate them simply using the HDMI CONTROL function. For details, see page 35.







### Note



- Depending on the system status, the volume level may not appear on the TV screen.
- When you set the HDMI CONTROL function to on, the TV that is connected to the unit with the HDMI cable can be synch-operated with the system. For details, see page 35.

## To save the power in standby mode

Press  while the system turns on. To cancel standby mode, press  once.

## Additional operations

To	Press
Stop	
Pause	
Resume play after pause	 or 
Go to the next chapter, track, or scene	 (except for JPEG)
Go back to the preceding chapter, track, or scene	 (except for JPEG)
Turn off the sound temporarily	MUTING. To cancel muting, press it again or VOLUME + to adjust the sound volume.

To	Press
Stop play and remove the disc	
Replay the previous scene*	 (instant replay) during playback.
Briefly fast forward the current scene**	 (instant advance) during playback.

\* DVD VIDEOS/DVD-RWs/DVD-Rs only.

\*\*DVD VIDEOS/DVD-RWs/DVD-Rs/DVD+RWs/DVD+Rs only.

### Note

- You may not be able to use the Instant Replay or Instant Advance function with some scenes.

## Enjoying the Radio or Other Components

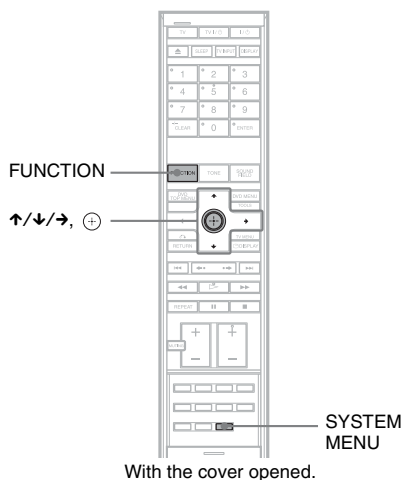

### Selecting the connected component

You can use a TV, VCR or other components connected to the TV, SAT/CABLE IN or VIDEO IN jacks on the rear panel. Refer to the operation manual supplied with the components for further information on the operation.

**Press FUNCTION repeatedly until the desired function name appears in the front panel display.**

Each time you press FUNCTION, the mode of the system changes in the following sequence.

DVD → FM → AM → TV → SAT/CABLE  
→ VIDEO → DMPORT1 → DMPORT2 →  
DVD → ...

#### Note

- When you set the [HDMI CONTROL] setting in [CUSTOM SETUP] to [ON] (page 82), the System Audio Control function is activated and no sound may be output from the TV. For details, see page 39.
- When you use both the analog connection and the digital connection at the same time, the digital connection takes priority (TV, SAT/CABLE, VIDEO).

### Changing the input level of the sound from connected components

Distortion may occur when listening to a component connected to the AUDIO (TV, SAT/CABLE, VIDEO) jack on the rear of the unit. This is not a malfunction and will depend on the component connected.

To prevent this, you can change the input level from the sound of the other components.

- 1 Press FUNCTION repeatedly until “TV,” “SAT/CABLE,” or “VIDEO” appears in the front panel display.**
- 2 Press SYSTEM MENU.**
- 3 Press ↑/↓ repeatedly until “ATTENUATE” appears in the front panel display, then press ⊕ or →.**
- 4 Press ↑/↓ to select a setting.**
  - “ATT ON”: attenuates the input level. Set this if distortion occurs during listening.
  - “ATT OFF”: normal input level. Set this if the input level is low.
- 5 Press ⊕.**
- 6 Press SYSTEM MENU.**  
The system menu turns off.

## Enjoying TV or VCR Sound from the speaker system

You can enjoy TV or VCR sound from the speakers in this system.

For details, see “TV Hookup (Advanced)” (page 20) and “Other Component Hookup” (page 25).

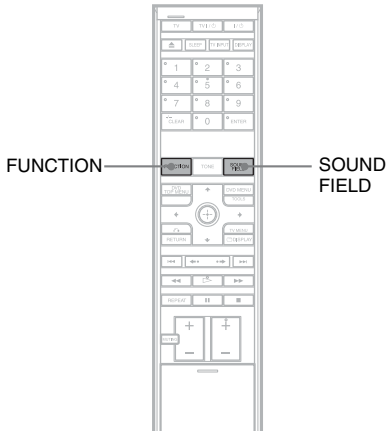

- 1 Press **FUNCTION** repeatedly until “TV,” “SAT/CABLE,” or “VIDEO” appears in the front panel display.
- 2 Press **SOUND FIELD** repeatedly until the sound field you want appears in the front panel display.

### Note

- When you set the [HDMI CONTROL] setting in [CUSTOM SETUP] to [ON] (page 82), the System Audio Control function is activated and no sound may be output from the TV. For details, see page 39.
- When you use both the analog connection and the digital connection at the same time, the digital connection takes priority (TV, SAT/CABLE, VIDEO).

## Selecting the Movie or Music Mode

**DVD-V** **DVD-VR** **VIDEO CD** **Super Audio CD** **C D**

**DATA-CD** **DATA DVD**

You can choose a suitable sound mode for movies or music.

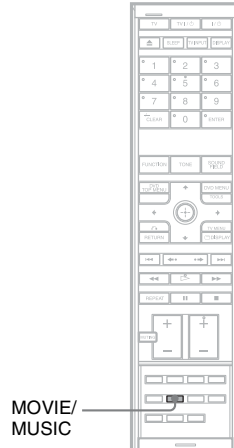

With the cover opened.

### Press MOVIE/MUSIC during playback.

Press MOVIE/MUSIC repeatedly until the mode you want lights up in the front panel display. The default setting is underlined.

- “AUTO”: selects the mode automatically to produce the sound effect depending on the disc or sound stream.
- “MOVIE”: provides sound suitable for movies.
- “MUSIC”: provides sound suitable for music.

### Tip

- When the movie or music mode is selected, “MOVIE” or “MUSIC” lights up in the front panel display. When neither “MOVIE” nor “MUSIC” lights up in the front panel display, “AUTO” is selected.

### Note

- Depending on the disc or source, when you select “AUTO,” the beginning of the sound may be cut off as the optimum mode is automatically selected. To avoid cutting the sound, select “MOVIE” or “MUSIC.”

## Sound Adjustments

# Enjoying Surround Sound by Using Sound Field

DVD-V   DVD-VR   VIDEO CD   C D   DATA-CD

DATA DVD

This system can create 5.1 channel surround sound from two front speakers and a subwoofer. You can take advantage of this front surround sound simply by selecting one of system's preprogrammed sound fields. They bring the exciting and powerful sound of movie theaters into your home.

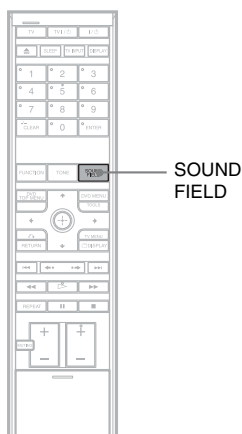

### Press SOUND FIELD.

The present sound field appears in the front panel display. Press SOUND FIELD repeatedly until the sound field you want appears in the front panel display.

### All sound field

Sound field	Display
AUTO	AUTO
2CH STEREO	2CH STEREO
PORTABLE AUDIO ENHANCER	P. AUDIO

### Tip

- The system memorizes the last sound field selected for each function mode. However, the system does not memorize the last sound field for the FM and AM functions individually – only the tuner function in general.
- If the AC power cord (mains lead) is disconnected for a long period of time, the system may return to its default settings.

## About S-Force PRO Front Surround

Sony's long-term involvement in surround technology (and the vast amounts of acoustic data accumulated as a result) has led to the development of an all-new processing method and advanced DSP to handle this task effectively, and which we call S-Force PRO Front Surround. Compared with previous front surround technologies, S-Force PRO Front Surround reproduces a more convincing sense of distance and space, resulting in a true surround sound experience without the need for rear speakers.

### Automatic sound field selection

#### ■ AUTO

This mode selects the sound field (Front Surround, 2CH STEREO or PORTABLE AUDIO ENHANCER) automatically according to the type of audio signal being input. The sound field is selected as follows.

- Front Surround: when an image disc (e.g., DVD, VCD, etc.) is played, or when the function is set to "TV," "SAT/CABLE," or "VIDEO."
- 2CH STEREO: when an audio disc (e.g., CD, Super Audio CD, DATA-CD (MP3), etc.) is played, or when the function is set to "FM" or "AM."
- P.AUDIO (PORTABLE AUDIO ENHANCER): when the function is set to "DMPORT1" or "DMPORT2."

### Note

- The sound field for Super Audio CDs is 2CH STEREO only.
- The surround effect might be difficult to hear depending on the type of source signals (e.g., digital stereo signals, digital multi signals, etc.) except for DVD multi-channel signals.



- Even if you select “AUTO,” the surround effect does not work when you play a CD or DATA CD, listen to the radio (FM/AM), or select the “DMPORT1” or “DMPORT2” function.

## 2 channel source output

### ■ 2CH STEREO

This mode outputs 2 channel sound regardless of the audio signal type being input.

### Enjoying the portable audio source

#### ■ PORTABLE AUDIO ENHANCER

This mode produces a clear enhanced sound image from your portable audio device. This mode is ideal for MP3, other compressed music.

## Adjusting the Bass Level and Treble Level

You can adjust the bass and treble level easily.

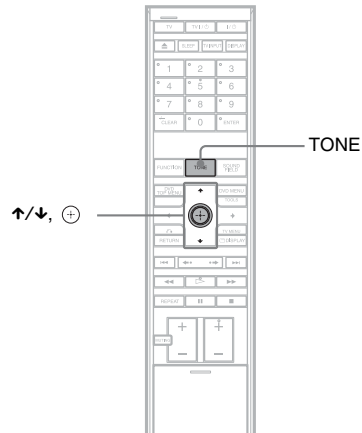

### 1 Press TONE repeatedly until “BASS” or “TREBLE” appears in the front panel display.

- “BASS”: adjusts the bass level (–6.0 dB – +6.0 dB, 0.5 dB increments).
- “TREBLE”: adjusts the treble level (–6.0 dB – +6.0 dB, 0.5 dB increments).

### 2 Press ↑/↓ to adjust.

The adjusted value appears in the front panel display.

### 3 Press ⊕.

#### Note

- When you perform the auto calibration (page 75), bass and treble levels return to their default settings.

# Enjoying the Sound at Low Volume

## **(NIGHT MODE)**

You can enjoy sound effects or dialog, as you would in a movie theater, even at low volume. It is useful for watching movies at night.

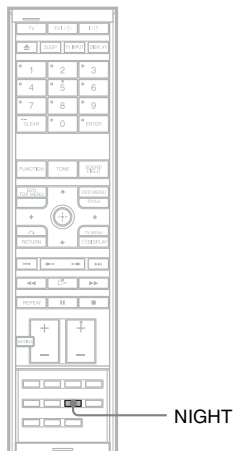

With the cover opened.

### **Press NIGHT.**

“NIGHT” lights up in the front panel display and the sound effect is activated.

#### **Tip**

- To enjoy more effects, set [AUDIO DRC] to [STANDARD] or [MAX] (page 82).

### **To turn off the sound effect**

Press NIGHT again.

## Using the HDMI CONTROL Function for 'BRAVIA' Theatre Sync

'BRAVIA' Theatre Sync can be used only with Sony 'BRAVIA' TVs that carry this function. By connecting Sony components that are compatible with the HDMI CONTROL function with an HDMI cable (not supplied), operation is simplified as below:

- One-Touch Play (page 38): By pressing only  $\triangleright$  on the remote, the TV turns on and is set for DVD input mode automatically, and the sound is output automatically from the speakers of this system.
- System Audio Control (page 39): While watching TV, you can select to output the sound from the TV speaker or the speakers of this system.
- System Power Off (page 40): When you turn the TV off by using the power button on the TV's remote, the system turns off simultaneously.

HDMI CONTROL is a mutual control function standard used by HDMI CEC (Consumer Electronics Control) for HDMI (high-definition multimedia interface).

The HDMI CONTROL function will not operate in the following cases:

- When you connect this system to a component which is not correspond with Sony's HDMI CONTROL function.
- When you connect the unit and components using other than the HDMI connection.

We recommend that you connect this system to products featuring 'BRAVIA' Theatre Sync.

### Note

- Depending on the connected component, the HDMI CONTROL function may not work. See the operating instructions of the component.

## Preparing for the HDMI CONTROL function

To use the HDMI CONTROL function, set up the system and the TV.

Before you use the HDMI CONTROL function, be sure you have performed the following procedures.

- 1** Make sure that the unit is connected to the TV (compatible with HDMI CONTROL function) via the HDMI connection.
- 2** Turn on the system and the TV.
- 3** Switch the input selector on the TV so that the signal from the system appears on the TV screen.
- 4** Set the respective HDMI CONTROL function for this system and the TV.

For details on this system, see "Setting [HDMI CONTROL] function" below. For details on the setting up TV, see the operating instructions of the TV. Depending on the TV, the default setting of the HDMI CONTROL function may be off.

### Setting [HDMI CONTROL] function

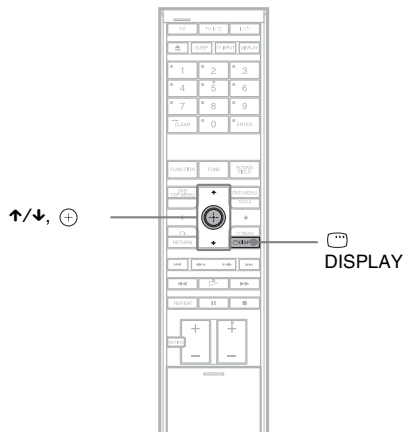

- 1** Press  DISPLAY when the system is in stop mode.  
The Control Menu display appears on the TV screen.

## 2 Press $\uparrow/\downarrow$ to select [SETUP], then press $\oplus$ .

The options for [SETUP] appear.

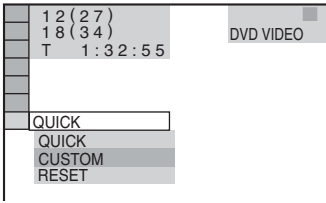

## 3 Press $\uparrow/\downarrow$ to select [CUSTOM], then press $\oplus$ .

The Setup Display appears.

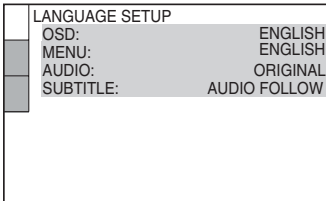

## 4 Press $\uparrow/\downarrow$ to select [CUSTOM SETUP], then press $\oplus$ .

The Setup item is selected.

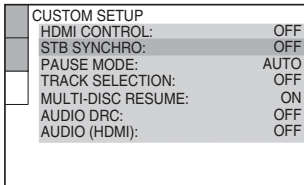

## 5 Press $\uparrow/\downarrow$ to select [HDMI CONTROL], then press $\oplus$ .

## 6 Press $\uparrow/\downarrow$ to select [ON].

The default setting is underlined.

- [OFF]: sets the [HDMI CONTROL] function to off.
- [ON]: sets the [HDMI CONTROL] function to on.

## 7 Press $\oplus$ .

### Note

- If [Please verify the HDMI connection.] appears in Step 6, check that this system and the TV are connected properly.

## Watching DVD by a Single Button Press

### (One-Touch Play)

Simply pressing by  (one-touch) on the remote, the system and the components with the HDMI connections turn on simultaneously, and then DVD playback starts automatically.

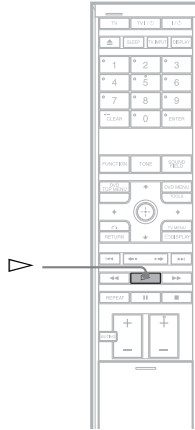

Check the HDMI connections of the respective component and make sure [HDMI CONTROL] is set to [ON] (page 36).

#### Press on the remote.

The system and the components with the HDMI connections turn on simultaneously, and DVD playback starts automatically.

This system and the TV operate as follows:

This system	TV
Turns on.	Turns on.
↓	↓
Switches to "DVD" function.	Switches to HDMI input.
↓	↓
Plays back a DVD and outputs the sound.	Minimizes sound level.

#### Note

- When a Super Audio CD/CD/DATA-CD is loaded into the unit, the One-Touch Play function does not work.
- When the "DMPORT" function is active, One-Touch Play will not work.
- Depending on the TV, the start of the content may not be output.

# Enjoying the TV Sound from the Speakers in this System

## (System Audio Control)

You can enjoy the TV sound from the speakers of this system by a simple operation.

To use System Audio Control, connect the unit and the TV with an audio cord (not supplied) (A) and an HDMI cable (not supplied) (B).

← : Signal flow

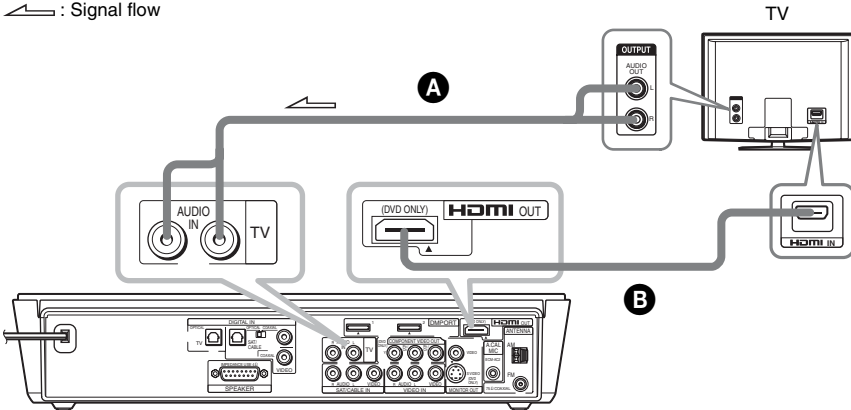

Depending on the TV setting, the system turns on and switches to “TV” function automatically while you are watching the TV. TV sound is output from the system speakers, and the volume of the TV speakers is minimized simultaneously.

You can use System Audio Control as follows:

- When you turn on this system while watching the TV, TV sound is output from the system speakers automatically.
- You can adjust the system volume using the TV volume.
- If you turn off the system, the sound will be output from the TV speakers.

You can also operate System Audio Control from the TV menu. For details, see the operating instructions of the TV.

### Note

- When the TV is turned on before turning on the system, the TV sound will not output for a moment.
- When you select the TV program (the active picture is highlighted) or return to the TV mode while watching the TV and a DVD by PAP (picture and picture) mode, the DVD playback will stop.
- To output the sound from the TV, set [AUDIO (HDMI)] to [AUTO] or [PCM] on the system (page 82).

## Turning off the System with the TV

### *(System Power Off)*

When you turn off the TV using the power button on the TV's remote, this system also turns off automatically.

To use System Power Off, connect the unit and the TV with an HDMI cable (not supplied). See page 39.

When you turn off the system by pressing **I/⏻** on the remote of the system or on the unit, the TV will not turn off.

#### **Note**

- Before using the System Power Off function, the TV function to link a power supply should be on. For details, see the operating instructions of the TV.
- Depending on the status, the system may not be turned off.



# Enjoying STB (Set Top Box) Digital Sound or Digital Satellite Receiver Sound from the System

## (STB SYNCHRO)

You can enjoy digital sound and images of STB or a digital satellite receiver. Sound is output from the speakers of this system. Images of STB or a digital satellite receiver are output from the TV by the HDMI connection. Follow the connections and settings.

### Connecting the system

Connect the STB to the HDMI input jack of the TV with an HDMI cable (not supplied) (make sure to connect from the smallest number).

By connecting as the following illustration, you can enjoy Multi Channel Broadcasted Audio from the speakers of this system.

#### Note

- To enjoy STB sound, the TV must be equipped with 2 HDMI input jacks.
- The names of HDMI inputs in the following illustration are examples.

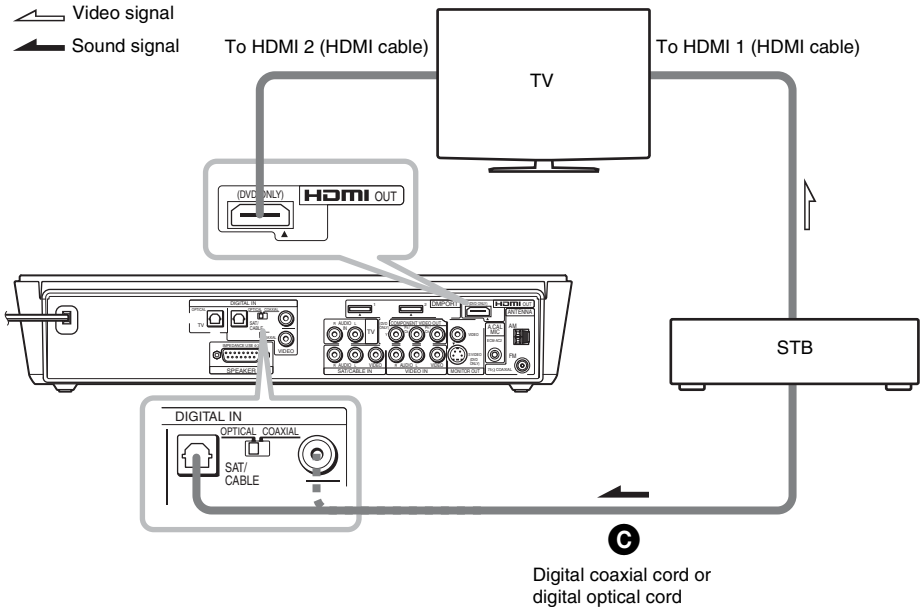

## Setting [STB SYNCHRO]

- 1 Press I/⏻.
- 2 Press DISPLAY when the system is in stop mode.
- 3 Press to select [SETUP], then press .
- 4 Press to select [CUSTOM], then press .
- 5 Press to select [CUSTOM SETUP], then press .

### Note

- In order to set the [STB SYNCHRO] function, first set [HDMI CONTROL] to [ON] (page 36).

- 6 Press to select [STB SYNCHRO], then press .
- 7 Press to select [ON].

The default setting is underlined.

- [OFF]: sets the [STB SYNCHRO] function to off.
- [ON]: sets the [STB SYNCHRO] function to on.

- 8 Set the switch on the rear panel according to whether an OPTICAL or COAXIAL cord (Ⓢ) is used.

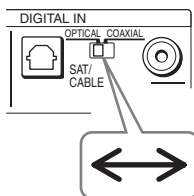

- 9 Press .

The setting is made.

### Tip

- You can operate this function on STB or a digital satellite receiver which is not compatible with HDMI CONTROL function.

### Note

- Depending on the TV, this function may not work when STB or a digital satellite receiver is connected to the HDMI 1 jack of the TV.

## Enjoying digital sound

Select the HDMI input of your TV connected to the STB or digital satellite receiver (HDMI 1 shown above).

The system accepts the signal from the SAT/CABLE (DIGITAL IN COAXIAL or OPTICAL) jack automatically and outputs the sound of the STB or digital satellite receiver from the speakers of the system.

## Various Functions for Playing Discs

### Searching for a Particular Point on a Disc

*(Scan, Slow-motion Play, Freeze Frame)*

DVD-V DVD-VR VIDEO CD Super Audio CD CD

DATA-CD DATA DVD

You can quickly locate a particular point on a disc by monitoring the picture or playing back slowly.

#### Note

- Depending on the DVD/VIDEO CD, you may not be able to do some of the operations described.

### Locating a point quickly by playing a disc in fast forward or fast reverse (Scan)

**(except for JPEG)**

Press **◀|/◀◀** or **▶▶/|▶** while playing a disc. When you find the point you want, press **▷** to return to normal speed. Each time you press **◀|/◀◀** or **▶▶/|▶** during scan, the playback speed changes. With each press the indication changes as shown below. Actual speeds may differ with some discs.

Playback direction

×2▶ → 1▶▶ → 2▶▶▶ → 3▶▶▶▶



3▶▶▶ (DVD VIDEO/DVD-VR mode/VIDEO CD only)  
×2▶ (DVD VIDEO/Super Audio CD/CD only)

Opposite direction

×2◀ → 1◀◀ → 2◀◀◀ → 3◀◀◀◀



3◀◀◀ (DVD VIDEO/DVD-VR mode/VIDEO CD only)  
×2◀ (DVD VIDEO only)

With each press, playback speed becomes faster.

### Watching frame by frame (Slow-motion Play)

**(DVD VIDEO, DVD-R, DVD-RW, VIDEO CD only)**

Press **◀|/◀◀** or **▶▶/|▶** when the system is in pause mode. To return to the normal playback speed, press **▷**. Each time you press **◀|/◀◀** or **▶▶/|▶** during Slow-motion Play, the playback speed changes. Two speeds are available. With each press the indication changes as follows:

Playback direction

2▶▶ ↔ 1▶▶

Opposite direction (DVD VIDEO/DVD-R/DVD-RW only)

2◀◀ ↔ 1◀◀

### Playing one frame at a time (Freeze Frame)

**(DVD VIDEO, DVD-R, DVD-RW, VIDEO CD only)**

When the system is in the pause mode, press **||▶** STEP (●→) to go to the next frame. Press **◀||** STEP (←●) to go to the preceding frame (DVD VIDEO/DVD-R/DVD-RW only). To return to normal playback, press **▷**.

#### Note

- You cannot search for a still picture on a DVD-R/DVD-RW in VR mode.

# Searching for a Title/ Chapter/Track/Scene, etc.

DVD-V   DVD-VR   VIDEO CD   Super Audio CD   C D  
DATA-CD   DATA DVD

You can search a DVD by title or chapter, and you can search a VIDEO CD/Super Audio CD/CD/DATA CD/DATA DVD by track, index, or scene. As titles and tracks are assigned unique numbers on the disc, you can select the desired one by entering its number. Or, you can search for a scene using the time code.

**1** Press **DISPLAY**. (When playing a DATA CD/DATA DVD with JPEG image files, press **DISPLAY** twice.)

The Control Menu display appears.

**2** Press to select the search method.

The display will show different items depending on the disc.

[TITLE], [SCENE], [TRACK]

[CHAPTER], [INDEX]

[TIME/TEXT]

Select [TIME/TEXT] to search for a starting point by inputting the time code.

[TRACK]

[INDEX]

[ALBUM]

[FILE]

Example: when you select [CHAPTER]

[\*\* (\*\*)] is selected (\*\* refers to a number).

The number in parentheses indicates the total number of titles, chapters, tracks, indexes, scenes, albums or files.

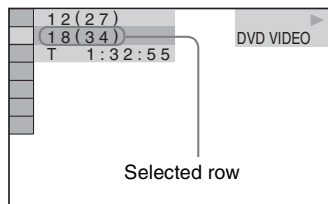

**3** Press .

[\*\* (\*\*)] changes to [-- (\*\*)].

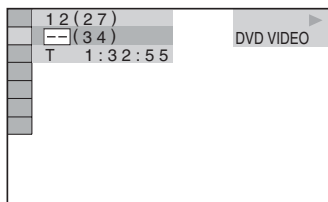

**4** Press or the number buttons to select the title, chapter, track, index, scene, etc., number you want to search for.

## If you make a mistake

Cancel the number by pressing CLEAR, then select another number.

**5** Press .

The system starts playback from the selected number.

## To search for a scene using the time code (DVD VIDEO and DVD-VR mode only)

**1** In Step 2, select [TIME/TEXT].

[T \*\*:\*\*:\*\*] (playing time of the current title) is selected.

**2** Press .

[T \*\*:\*\*:\*\*] changes to [T --:--:--].

**3** Input the time code using the number buttons, then press .

For example, to find the scene at 2 hours, 10 minutes, and 20 seconds after the beginning, just enter “21020.”

**Tip**

- When the Control Menu display is turned off, you can search for a chapter (DVD VIDEO/DVD-R/DVD-RW) or track (VIDEO CD/Super Audio CD/CD) by pressing the number buttons and  $\oplus$ .

**Note**

- You cannot search for a scene on a DVD+RW using the time code.

## Searching by Scene

### (Picture Navigation)

**DVD-V** **VIDEO CD**

You can divide the screen into 9 subscreens and find the desired scene quickly.

- 1 Press PICTURE NAVI during playback.**  
The following display appears.

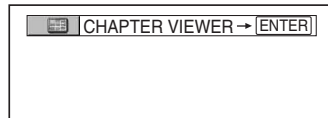

- 2 Press PICTURE NAVI repeatedly to select an item.**

- [TITLE VIEWER] (DVD VIDEO only)
- [CHAPTER VIEWER] (DVD VIDEO only)
- [TRACK VIEWER] (VIDEO CD/Super VCD only)

- 3 Press  $\oplus$ .**

The first scene of each title, chapter, or track appears as follows.

1	2	3	
4	5	6	
7	8	9	▼

- 4 Press  $\leftarrow/\uparrow/\downarrow/\rightarrow$  to select a title, chapter, or track, and press  $\oplus$ .**

The system starts playback from the selected scene.

### To return to normal play during setting

Press  $\circlearrowleft$  RETURN.

**Note**

- Depending on the disc, you may not be able to select some items.

# Resuming Playback from the Point Where You Stopped the Disc

## (Resume Play)



When you stop the disc, the system remembers the point where you pressed ■ and “Resume” appears in the front panel display. As long as you do not remove the disc, Resume Play will work even if the system enters standby mode by pressing I/⏻.

### 1 While playing a disc, press ■ to stop playback.

“Resume” appears in the front panel display.

If “Resume” does not appear, Resume Play is not available.

### 2 Press ▷.

The system starts playback from the point where you stopped the disc in Step 1.

#### Note

- Depending on where you stop the disc, the system may not resume playback from exactly the same point.
- The point where you stopped playing may be cleared when:
  - you eject the disc.
  - the system enters standby mode (DATA CD/ DATA DVD only).
  - you change or reset the settings on the Setup Display.
  - you change the parental control level.
  - you change the function by pressing FUNCTION.
  - you disconnect the AC power cord (mains lead).
- For DVD-Rs/DVD-RWs in VR mode, VIDEO CDs, Super Audio CDs, CDs, DATA CDs, and DATA DVDs, the system remembers the resume playback point for the current disc.
- Resume Play does not work during Program Play and Shuffle Play.
- This function may not work properly with some discs.

#### Tip

- To play from the beginning of the disc, press ■ twice, then press ▷.

## To enjoy a disc that is played before by resume playback (Multi-disc Resume) (DVD VIDEO, VIDEO CD only)

This system recalls the point where you stopped the disc the last time it was played and resumes playback from that point the next time you insert the same disc. When the resume playback memory is full, the resume playback point for the first disc is deleted.

To activate this function, set [MULTI-DISC RESUME] in [CUSTOM SETUP] to [ON]. For details, see “[MULTI-DISC RESUME] (DVD VIDEO/VIDEO CD only)” (page 82).

#### Tip

- This system can store at least 10 resume playback points.
- To play from the beginning of the disc, press ■ twice, then press ▷.

#### Note

- If [MULTI-DISC RESUME] in [CUSTOM SETUP] is set to [OFF] (page 82), the resume point is cleared when you change the function by pressing FUNCTION.

# Creating Your Own Program

## (Program Play)

VIDEO CD Super Audio CD CD

You can play the contents of a disc in the order you want by arranging the order of the tracks on the disc to create your own program. You can program up to 99 tracks.

### Note

• You can program the track on the current disc only.

#### 1 Press DISPLAY.

The Control Menu display appears.

#### 2 Press to select [PROGRAM], then press .

The options for [PROGRAM] appear.

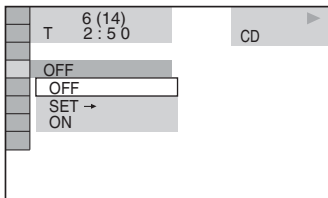

#### 3 Press to select [SET ->], then press .

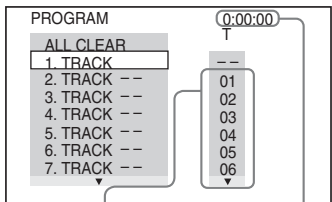

Tracks recorded on a disc

Total time of programmed tracks

#### 4 Press .

The cursor moves to the track row [T] (in this case, [01]).

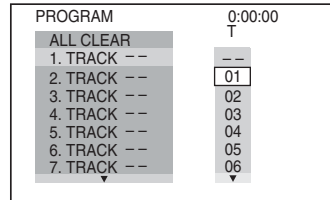

#### 5 Select the track you want to program.

For example, select track [02].

Press to select [02] under [T], then press . The track number may be displayed in three digits for a Super Audio CD.

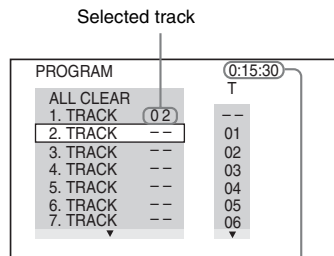

Total time of programmed tracks

#### 6 To program other tracks, repeat steps 4 to 5.

The programmed tracks are displayed in the selected order.

#### 7 Press to start Program Play.

Program Play starts.

When the program ends, you can restart the same program again by pressing .

### To return to normal play

In Step 3, press CLEAR or select [OFF]. To play the same program again, select [ON] in Step 3 and press .

### To turn off the Control Menu display

Press DISPLAY repeatedly until the Control Menu display is turned off.

## To change or cancel a program

- 1 Follow steps 1 to 3 of “Creating Your Own Program.”
- 2 Select the program number of the track you want to change or cancel using  $\uparrow/\downarrow$ . If you want to delete the track from the program, press CLEAR.
- 3 Follow Step 5 for new programming. To cancel a program, select [--] under [T], then press  $\oplus$ .

## To cancel all of the tracks in the programmed order

- 1 Follow steps 1 to 3 of “Creating Your Own Program.”
- 2 Press  $\uparrow$  and select [ALL CLEAR].
- 3 Press  $\oplus$ .

## Playing in Random Order

### (Shuffle Play)

VIDEO CD Super Audio CD CD DATA-CD DATA DVD

You can have the system “shuffle” tracks. Subsequent “shuffling” may produce a different playing order.

#### Note

- Same song may be played repeatedly during MP3 playback.

- 1 Press  $\text{[DISPLAY]}$  during playback.

The Control Menu display appears.

- 2 Press  $\uparrow/\downarrow$  to select  $\text{[SHUFFLE]}$ , then press  $\oplus$ .

The options for [SHUFFLE] appear.

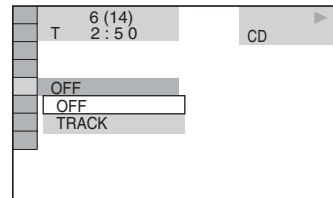

- 3 Press  $\uparrow/\downarrow$  to select the item to be shuffled.

#### ■ When playing a VIDEO CD, Super Audio CD, or CD

- [TRACK]: shuffles tracks on the disc.

#### ■ When Program Play is activated

- [ON]: shuffles tracks selected in Program Play.

#### ■ When playing a DATA CD or DATA DVD

- [ON]: shuffles MP3 audio tracks in the album on the current disc. When no album is selected, the first album will play in random order.

#### Note

- A track already played is also selected in random order.

- 4 Press  $\oplus$ .

Shuffle Play starts.



## To return to normal play

In Step 3, press CLEAR or select [OFF].

## To turn off the Control Menu display

Press DISPLAY repeatedly until the Control Menu display is turned off.

**Note**

- You cannot use this function with VIDEO CDs and Super VCDs with PBC playback.

# Playing Repeatedly

## (Repeat Play)



You can play all the titles, tracks or albums on a disc or a single title, chapter, track, or album repeatedly.

You can use a combination of Shuffle or Program Play modes.

**1** Press DISPLAY during playback.

The Control Menu display appears.

**2** Press  $\uparrow/\downarrow$  to select [REPEAT], then press  $\oplus$ .

The options for [REPEAT] appear.

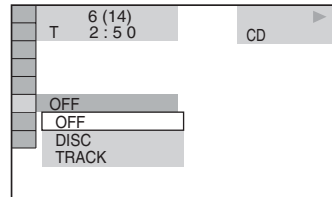

**3** Press  $\uparrow/\downarrow$  to select the item to be repeated.

The default setting is underlined.

**■ When playing a DVD VIDEO or DVD-VR**

- [OFF]: does not play repeatedly.
- [DISC]: repeats all of the titles on the disc.
- [TITLE]: repeats the current title on a disc.
- [CHAPTER]: repeats the current chapter.

**■ When playing a VIDEO CD, Super Audio CD, or CD**

- [OFF]: does not play repeatedly.
- [DISC]: repeats all of the tracks on the disc.
- [TRACK]: repeats the current track.

### ■ When playing a DATA CD or DATA DVD

- [OFF]: does not play repeatedly.
- [DISC]: repeats all of the albums on the disc.
- [ALBUM]: repeats the current album.
- [TRACK] (MP3 audio tracks only): repeats the current track.

## 4 Press $\oplus$ .

The item is selected.

### To return to normal play

In Step 3, press CLEAR or select [OFF].

### To turn off the Control Menu display

Press  $\square$  DISPLAY repeatedly until the Control Menu display is turned off.

#### Note

- You can quickly display the [REPEAT] status. Press REPEAT on the remote.
- You cannot use this function with VIDEO CDs and Super VCDs with PBC playback.
- When playing a DATA CD/DATA DVD which contains MP3 audio track and JPEG image files, and their playing time are not the same, the audio sound will not match the image.
- When [MODE (MP3, JPEG)] is set to [IMAGE (JPEG)] (page 61), you cannot select [TRACK].

#### Tip

- You can also press REPEAT on the remote to set repeat play.

## Using the DVD's Menu

### DVD-V

A DVD is divided into a lot of sections, which make up a picture or music feature. These sections are called "titles." When you play a DVD which contains several titles, you can select the title you want using DVD TOP MENU.

When you play DVDs that allow you to select items such as the language for the subtitles and the language for the sound, select these items using DVD MENU.

### 1 Press DVD TOP MENU or DVD MENU.

The disc's menu appears on the TV screen. The contents of the menu vary from disc to disc.

### 2 Press $\leftarrow/\uparrow/\downarrow/\rightarrow$ or the number buttons to select the item you want to play or change.

### 3 Press $\oplus$ .

# Changing the Sound

DVD-V

DVD-VR

VIDEO CD

CD

DATA-CD

DATA DVD

When playing a DVD VIDEO recorded in multiple audio formats (PCM, Dolby Digital, MPEG audio, or DTS), you can change the audio format. If the DVD VIDEO is recorded with multilingual tracks, you can also change the language.

With VIDEO CDs, CDs, DATA CDs, or DATA DVDs, you can select the sound from the right or left channel and listen to the sound of the selected channel through both the right and left speakers.

## 1 Press AUDIO during playback.

The following display appears.

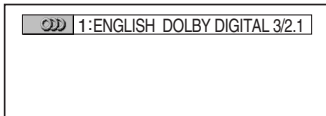

## 2 Press AUDIO repeatedly to select the desired audio signal.

### ■ When playing a DVD VIDEO

Depending on the DVD VIDEO, the choice of language varies.

When four digits are displayed, they indicate a language code. Refer to “Language Code List” (page 95) to see which language the code represents. When the same language is displayed two or more times, the DVD VIDEO is recorded in multiple audio formats.

### ■ When playing a DVD-VR

The types of sound tracks recorded on a disc are displayed. The default setting is underlined.

Example:

- [1: MAIN] (main sound)
- [1: SUB] (sub sound)
- [1: MAIN+SUB] (main and sub sound)
- [2: MAIN]
- [2: SUB]
- [2: MAIN+SUB]

### Note

- [2: MAIN], [2: SUB], and [2: MAIN+SUB] do not appear when one audio stream is recorded on the disc.

### ■ When playing a VIDEO CD, CD, DATA CD (MP3 audio), or DATA DVD (MP3 audio)

The default setting is underlined.

- [STEREO]: the standard stereo sound
- [1/L]: the sound of the left channel (monaural)
- [2/R]: the sound of the right channel (monaural)

### ■ When playing a Super VCD

The default setting is underlined.

- [1:STEREO]: the stereo sound of the audio track 1
- [1:1/L]: the sound of the left channel of the audio track 1 (monaural)
- [1:2/R]: the sound of the right channel of the audio track 1 (monaural)
- [2:STEREO]: the stereo sound of the audio track 2
- [2:1/L]: the sound of the left channel of the audio track 2 (monaural)
- [2:2/R]: the sound of the right channel of the audio track 2 (monaural)

### Note

- While playing a Super VCD on which audio track 2 is not recorded, no sound will come out if you select [2:STEREO], [2:1/L], or [2:2/R].
- You cannot change the sound for Super Audio CDs.

## Checking the audio signal format (DVD VIDEO only)

If you press AUDIO repeatedly during playback, the format of the current audio signal (PCM, Dolby Digital, DTS, etc.) appears as shown below.

### ■ When playing a DVD

#### Example:

Dolby Digital 5.1 ch

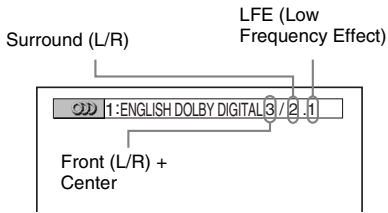

#### Example:

Dolby Digital 3 ch

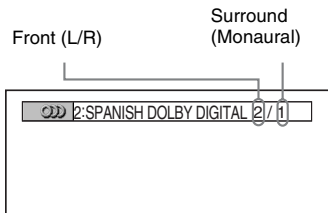

## About audio signals

Audio signals recorded in a disc contain the sound elements (channels) shown below.

- Front (L)
- Front (R)
- Center
- Surround (L)
- Surround (R)
- Surround (Monaural): This signal can be either Dolby Surround Sound processed signals or Dolby Digital sound's monaural Surround audio signals.
- LFE (Low Frequency Effect) signal

## Selecting [ORIGINAL] or [PLAY LIST] on a DVD-R/ DVD-RW

### DVD-VR

Some DVD-Rs/DVD-RWs in VR (Video Recording) mode have two types of titles for playback: originally recorded titles ([ORIGINAL]) and titles that can be created on recordable DVD players for editing ([PLAY LIST]). You can select the type of title to be played.

**1** Press **DISPLAY** when the system is in stop mode.

The Control Menu display appears.

**2** Press **↑/↓** to select **[ORIGINAL/PLAY LIST]**, then press **+**.

The options for [ORIGINAL/PLAY LIST] appear.

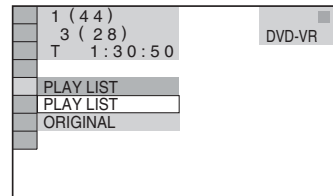

**3** Press **↑/↓** to select a setting.

The default setting is underlined.

- **[PLAY LIST]**: plays the titles created from [ORIGINAL] for editing.
- **[ORIGINAL]**: plays the titles originally recorded.

**4** Press **+**.

## Changing the Display Mode

### (INFORMATION MODE)

You can change the displayed information in the front panel display.

- 1 Press SYSTEM MENU.**
- 2 Press  $\uparrow/\downarrow$  repeatedly until “INFO MODE” appears in the front panel display, then press  $\oplus$  or  $\rightarrow$ .**
- 3 Press  $\uparrow/\downarrow$  to select a setting.**

The default setting is underlined.

  - “STANDARD”: displays information fully such as the kind of disc, track number, repeat mode information, radio frequency, etc., for the selected function. For details of the displayed information, see “Front Panel Display” (page 98).
  - “SIMPLE”: displays the selected function name only.
- 4 Press  $\oplus$ .**

The setting is made.
- 5 Press SYSTEM MENU.**

The system menu turns off.

## Viewing Information About the Disc

DVD-V DVD-VR VIDEO CD Super Audio CD C D

DATA-CD DATA DVD

### Viewing the playing time and remaining time in the front panel display

You can check disc information, such as the remaining time, total number of titles in a DVD, tracks in a VIDEO CD, Super Audio CD, CD, or MP3 using the front panel display (page 98).

#### Press DISPLAY.

Each time you press DISPLAY while playing the disc, the display changes ①  $\rightarrow$  ②  $\rightarrow$  ...  $\rightarrow$  ①  $\rightarrow$  ...

Some displayed items may disappear after a few seconds.

#### When playing a DVD VIDEO or DVD-R/DVD-RW

- ① Playing time and number of the current title
- ② Remaining time and number of the current title
- ③ Playing time and number of the current chapter
- ④ Remaining time and number of the current chapter
- ⑤ Disc name
- ⑥ Title and chapter

#### When playing a VIDEO CD (without PBC functions), Super Audio CD, or CD

- ① Playing time and number of the current track
- ② Remaining time and number of the current track
- ③ Playing time of the disc
- ④ Remaining time of the disc
- ⑤ Disc name
- ⑥ Track and index\*

\* VIDEO CD/Super Audio CD only.

## When playing a DATA CD (MP3 audio) or DATA DVD (MP3 audio)

- ① Playing time and current track number
- ② Track (file) name

### Tip

- When playing VIDEO CDs with PBC functions, the playing time is displayed.

### Note

- The system can only display the first level of the DVD/CD text, such as the Disc name or title.
- If an MP3 file name cannot be displayed, "\*" will appear in the front panel display instead.
- The disc name or track name may not be displayed depending on the text.
- Playing time of MP3 audio tracks may not be displayed correctly.

---

## Checking the playing time and remaining time

You can check the playing time and remaining time of the current title, chapter, or track, and the total playing time or remaining time of the disc. You can also check the DVD text and MP3 folder name/file name recorded on the disc.

### 1 Press DISPLAY during playback.

The following display appears.

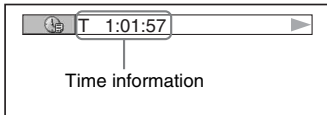

### 2 Press DISPLAY repeatedly to change the time information.

The display and the kinds of time that you can check depend on the disc you are playing.

#### ■ When playing a DVD VIDEO or DVD-RW

- T \*\*: \*\*: \*\*  
Playing time of the current title
- T \_ \*\*: \*\*: \*\*  
Remaining time of the current title
- C \*\*: \*\*: \*\*  
Playing time of the current chapter
- C \_ \*\*: \*\*: \*\*  
Remaining time of the current chapter

#### ■ When playing a VIDEO CD (with PBC functions)

- \*\*: \*\*: \*\*

Playing time of the current scene

#### ■ When playing a VIDEO CD (without PBC functions), Super Audio CD, or CD

- T \*\*: \*\*: \*\*

Playing time of the current track

- T \_ \*\*: \*\*: \*\*

Remaining time of the current track

- D \*\*: \*\*: \*\*

Playing time of the current disc

- D \_ \*\*: \*\*: \*\*

Remaining time of the current disc

#### ■ When playing a DATA CD (MP3 audio) or DATA DVD (MP3 audio)

- T \*\*: \*\*: \*\*

Playing time of the current track

### Note

- Characters/marks may not be displayed for some languages.
- Depending on the type of disc being played, the system can only display a limited number of characters. Also, depending on the disc, not all text characters will be displayed.

---

## Checking the play information of the disc

### To check DVD/Super Audio CD/CD text

Press DISPLAY repeatedly in Step 2 to display text recorded on the DVD/Super Audio CD/CD. The DVD/Super Audio CD/CD text appears only when text is recorded in the disc. You cannot change the text. If the disc does not contain text, "NO TEXT" appears.

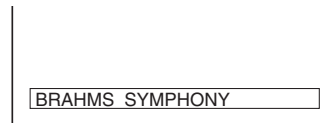

### To check DATA CD/DATA DVD (MP3 audio) text

By pressing DISPLAY while playing MP3 audio tracks on a DATA CD/DATA DVD, you can display the name of the album/track/file, and

the audio bit rate (the amount of data per second of the current audio) on your TV screen.

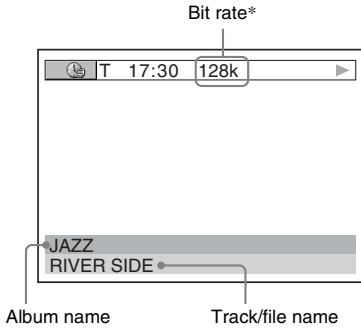

\* Appears when playing an MP3 audio track on DATA CDs/DATA DVDs.

## Checking the date information (JPEG only)

You can check the date information during playback when the Exif\* tag is recorded in JPEG image data.

Press **DISPLAY** twice during playback.

The Control Menu display appears.

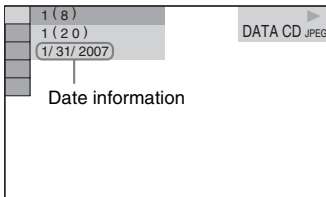

\* “Exchangeable Image File Format” is a digital camera image format defined by the Japan Electronics and Information Technology Industries Association (JEITA).

### Tip

- Date information is [MM/DD/YYYY].  
MM: Month  
DD: Day  
YYYY: Year

## Changing the Angles

### DVD-V

If various angles (multi-angles) for a scene are recorded on a DVD VIDEO, you can change the viewing angle.

**Press ANGLE during playback.**

Each time you press ANGLE, the angle changes.

### Note

- Depending on the DVD VIDEO, you may not be able to change the angle even if multi-angles are recorded on the DVD VIDEO.

## Displaying the Subtitles

DVD-V DVD-VR

If subtitles are recorded on a disc, you can turn the subtitles on or off while playing. If multilingual subtitles are recorded on the disc, you can change the subtitle language while playing, or turn the subtitles on or off whenever you want.

### Press SUBTITLE during playback.

Each time you press SUBTITLE, the subtitle language changes.

#### Note

- Depending on the DVD VIDEO, you may not be able to change the subtitles even if multilingual subtitles are recorded on it. You also may not be able to turn them off.

## Adjusting the Delay Between the Picture and Sound

### (A/V SYNC)

DVD-V DVD-VR VIDEO CD

When the sound does not match the pictures on the screen, you can adjust the delay between the picture and sound.

- 1 Press SYSTEM MENU.**
- 2 Press ↑/↓ repeatedly until “A/V SYNC” appears in the front panel display, then press ⊕ or →.**
- 3 Press ↑/↓ to select a setting.**

The default setting is underlined.

  - “OFF”: does not adjust.
  - “SHORT”: adjusts the difference between picture and sound by 70 msec.
  - “LONG”: adjusts the difference between picture and sound by 130 msec.
- 4 Press ⊕.**
- 5 Press SYSTEM MENU.**

The system menu turns off.



## Selecting a Playback Layer for a Super Audio CD

### Super Audio CD

Some Super Audio CDs consist of a Super Audio CD layer and a CD layer. You can select the playback layer you want to listen to.

### Note

- You can change a playback layer only when the unit recognises a hybrid disc.

- 1 Press SYSTEM MENU.**
- 2 Press  $\uparrow/\downarrow$  repeatedly until “SA-CD/CD” appears in the front panel display, then press  $\oplus$  or  $\rightarrow$ .**
- 3 Press  $\oplus$ .**
  - “CHANGE?”: Each time you press  $\oplus$ , a Super Audio CD layer or a CD layer is alternately selected. When playing a Super Audio CD layer, “SA-CD” lights up in the front panel display.

### Note

- For details about Super Audio CD discs, see page 93.
- Program Play, Shuffle Play, or Repeat Play mode works only within the selected playback layer.
- You cannot change a playback layer during playback.
- Super Audio CD audio signals are not output from the HDMI OUT (high-definition multimedia interface out) jack.

## About MP3 Audio Tracks and JPEG Image Files

### DATA-CD DATA DVD

### What is MP3/JPEG?

MP3 is audio compression technology that satisfies the ISO/MPEG regulations. JPEG is image compression technology.

### Discs that the system can play

You can play back DATA CDs (CD-ROMs/CD-Rs/CD-RWs) or DATA DVDs (DVD-Rs/DVD-RWs/DVD+Rs/DVD+RWs/DVD-ROMs) recorded in MP3 (MPEG1 Audio Layer 3) or JPEG format. However, the DATA CDs must be recorded according to ISO 9660 Level 1, Level 2 or Joliet format and DATA DVDs of Universal Disk Format (UDF) for the system to recognize the tracks (or files). You can also play discs recorded in Multi Session.

See the instructions supplied with the CD-R/CD-RW or DVD-R/DVD-RW drives and the recording software (not supplied) for details on the recording format.

### About Multi-Session disc

If MP3 audio tracks or JPEG image files are recorded in the first session, the system will also play MP3 audio tracks or JPEG image files in other sessions. If audio tracks and images in audio CD format or VIDEO CD format are recorded in the first session, only the first session will be played back.

### Note

- The system may not be able to play some DATA CDs/DATA DVDs created in the Packet Write format.

### MP3 audio track or JPEG image file that the system can play

The system can play MP3 audio tracks or JPEG image files:

- that have the extension “.MP3” (MP3 audio track) or “.JPG”/“.JPEG” (JPEG image file)
- that conform to the DCF\* image file format
- \* “Design rule for Camera File system”: Image standards for digital cameras regulated by Japan Electronics and Information Technology Industries Association (JEITA).

**Note**

- The system will play any data with the extension “.MP3,” “.JPG,” or “.JPEG” even if they are not in MP3 or JPEG format. Playing this data may generate a loud noise which could damage your speaker system.
- The system does not conform to audio in MP3PRO format.

## Playback order of MP3 audio tracks or JPEG image files

The playback order of MP3 audio tracks or JPEG image files recorded on a DATA CD or DATA DVD is as follows:

### ■ Structure of disc contents

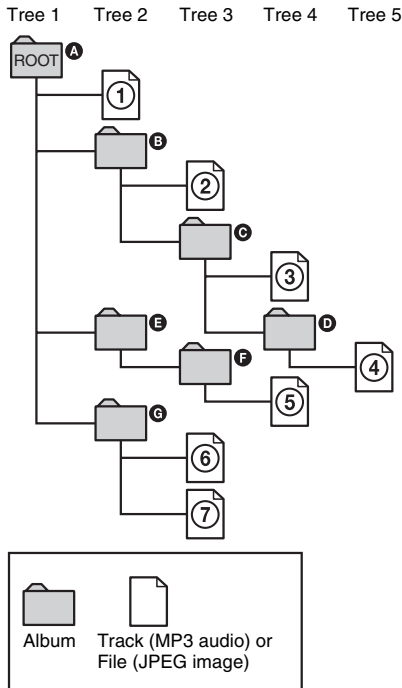

When you insert a DATA CD or DATA DVD and press  $\triangleright$ , the numbered tracks (or files) are played sequentially, from ① through ⑦. Any sub-albums/tracks (or files) contained within a currently selected album take priority over the next album in the same tree. (Example: C contains D so ④ is played before ⑤.)

When you press DVD MENU and the list of album names appears (page 59), the album names are arranged in the following order: A → B → C → D → F → G. Albums that do not contain tracks (or files) (such as album E) do not appear in the list.

**Tip**

- If you add numbers (01, 02, 03, etc.) to the front of the track (or file) names when you store the tracks (or files) in a disc, the tracks (or files) will be played in that order.
- A disc with many trees takes longer to start playback.

**Note**

- Playback order may differ from the illustration depending on the software you use to create the DATA CD or DATA DVD, or if there are more than 200 albums and 300 tracks (or files) in each album.
- The system can recognize up to 200 albums, and will not play any albums beyond the 200th.
- The system may take longer time to playback when progressing to the following album or jump to other album.
- Some types of JPEG files cannot be played.

# Playing DATA CDs or DATA DVDs with MP3 Audio Tracks and JPEG Image Files

DATA-CD DATA DVD

## Selecting an MP3 audio track or album

### 1 Load a DATA CD or DATA DVD.

The albums recorded on the DATA CD or DATA DVD appear. When an album is being played, its title is shaded.

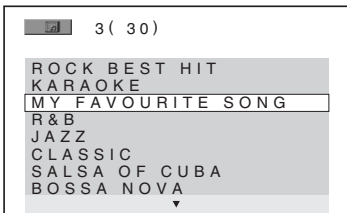

### 2 Press $\uparrow/\downarrow$ to select an album.

#### ■ When selecting an album

Press  $\triangleright$  to start playing the selected album.

#### ■ When selecting a track

Press  $\oplus$ .

A list of the tracks contained in the album appears.

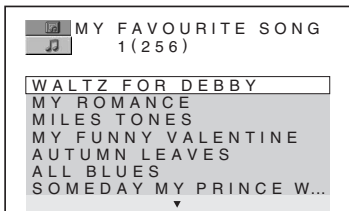

Press  $\uparrow/\downarrow$  to select a track and press  $\oplus$ .

The selected track starts playing. You can turn the track list off by pressing DVD MENU. Pressing DVD MENU again will display the album list.

## To stop playback

Press  $\blacksquare$ .

## To play the next or previous MP3 audio track

Press  $\lll/\ggg$ . Note that you can select the next album by continuing to press  $\ggg$  after the last track on the current album, but that you cannot return to the previous album by pressing  $\lll$ . To return to a previous album, select the album from the album list.

## To return to the previous display

Press  $\curvearrowright$  RETURN.

## To turn off the display

Press DVD MENU.

## Selecting a JPEG image file or album

### 1 Load a DATA CD or DATA DVD.

The albums recorded on the DATA CD or DATA DVD appear. When an album is being played, its title is shaded.

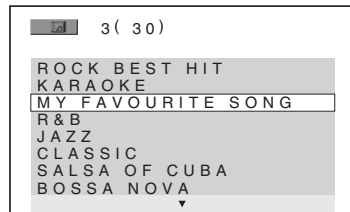

### 2 Press $\uparrow/\downarrow$ to select an album.

#### ■ When selecting an album

Press  $\triangleright$  to start playing the selected album.

### ■ When selecting an image

Press PICTURE NAVI.

Images of files in the album appear in 16 subscreens.

1	2	3	4
5	6	7	8
9	10	11	12
13	14	15	16

Press  $\leftarrow$ / $\uparrow$ / $\downarrow$ / $\rightarrow$  to select the image you want to view and press  $\oplus$ .

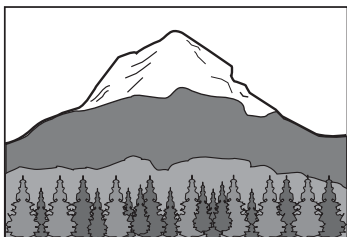

Rotating direction

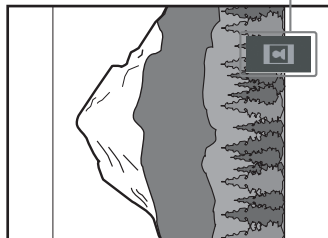

Press CLEAR to return to normal view.

### To stop playback

Press ■.

#### Tip

- A scroll box is displayed at the right side of the screen. To display the additional image files, select the bottom image and press  $\downarrow$ . To return to the previous image, select the top image and press  $\uparrow$ .

### To play the next or previous JPEG image file

Press  $\leftarrow$ / $\rightarrow$  when the Control Menu display is not displayed. Note that you can select the next album by continuing to press  $\rightarrow$  after the last image on the current album, but that you cannot return to the previous album by pressing  $\leftarrow$ . To return to the previous album, select the album from the album list.

### To rotate a JPEG image

When a JPEG image file is displayed on the screen, you can rotate the image by 90 degrees. Press  $\uparrow$ / $\downarrow$  while viewing an image. Each time you press  $\uparrow$ , the image rotates counterclockwise by 90 degrees.

Example of when you press  $\uparrow$  once:

# Playing Audio Tracks and Images as a Slide Show with Sound

**DATA-CD DATA DVD**

You can play a slide show with sound by first placing both MP3 and JPEG files in the same album on a DATA CD or DATA DVD. When you play back the DATA CD or DATA DVD, select [AUTO] mode as explained below.

- 1 Load a DATA CD or DATA DVD.**
- 2 Press  DISPLAY when the system is in stop mode.**

The Control Menu display appears.

- 3 Press  $\uparrow/\downarrow$  to select  [MODE (MP3, JPEG)], then press  $\oplus$ .**

The options for [MODE (MP3, JPEG)] appear.

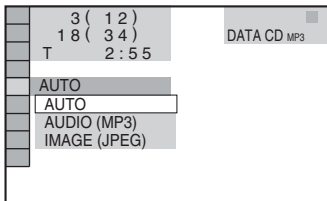

- 4 Press  $\uparrow/\downarrow$  to select a setting.**

The default setting is underlined.

- [AUTO]: plays both the JPEG image files and MP3 audio tracks in the same album as a slide show.
- [AUDIO (MP3)]: plays only MP3 audio tracks continuously.
- [IMAGE (JPEG)]: plays only JPEG image files as a slide show.

- 5 Press  $\oplus$ .**

- 6 Press DVD MENU.**

The list of albums recorded on the DATA CD or DATA DVD appears.

- 7 Press  $\uparrow/\downarrow$  to select the album you want and press  $\triangleright$ .**

The system starts playing the selected album.

You can turn the album list on and off by pressing DVD MENU repeatedly.

**TIP**

- When you select [AUTO], the system can recognize up to 300 MP3 tracks and 300 JPEG files in a single album. When you select [AUDIO (MP3)] or [IMAGE (JPEG)], the system can recognize up to 600 MP3 and 600 JPEG files in a single album. A maximum of 200 albums can be recognized regardless of the selected mode.

**Note**

- If you set [MODE (MP3, JPEG)] to [IMAGE (JPEG)] on a disc that contains MP3 tracks only or [AUDIO (MP3)] on a disc that contains JPEG files only, you may not be able to change the [MODE (MP3, JPEG)] setting.
- PICTURE NAVI does not work when [AUDIO (MP3)] is selected.
- If you play large MP3 track data and JPEG image data at the same time, the sound may skip. It is recommended that you set the MP3 bit rate to 128 kbps or lower when creating the file. If the sound still skips, then reduce the size of the JPEG file.

## Specifying the slide show duration (JPEG only)

When you play JPEG image files using slide show, you can specify the duration for slides to appear on the screen.

- 1 Press  DISPLAY twice.**

The Control Menu display for JPEG appears.

- 2 Press  $\uparrow/\downarrow$  to select  [INTERVAL], then press  $\oplus$ .**

The options for [INTERVAL] appear.

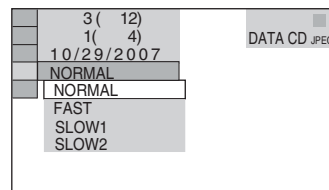

### 3 Press $\uparrow/\downarrow$ to select a setting.

The default setting is underlined.

- [NORMAL]: sets the duration to about 6 to 9 seconds.
- [FAST]: sets the duration shorter than [NORMAL].
- [SLOW1]: Sets the duration longer than [NORMAL].
- [SLOW2]: Sets the duration longer than [SLOW1].

### 4 Press $\oplus$ .

#### Note

- Some JPEG files may take longer to display than others, which may make the duration seems longer than the option you selected. Especially progressive JPEG files or JPEG files of 3,000,000 pixels or more.

---

## Selecting an effect for image files in the slide show (JPEG only)

When you play a JPEG image file, you can select the effect to be used when viewing the slide show.

### 1 Press $\text{DISP}$ DISPLAY twice.

The Control Menu display for JPEG appears.

### 2 Press $\uparrow/\downarrow$ to select $\text{[EFFECT]}$ , then press $\oplus$ .

The options for [EFFECT] appear.

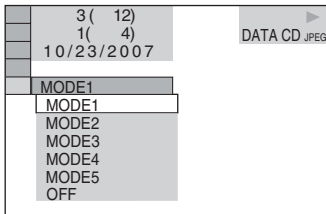

### 3 Press $\uparrow/\downarrow$ to select the setting you want.

The default setting is underlined.

- [MODE1]: The image sweeps in from top to bottom.
- [MODE2]: The image stretches out from left to right of the screen.
- [MODE3]: The image stretches out from the center of the screen.
- [MODE4]: The images randomly cycle through the effects.
- [MODE5]: The next image slides over the previous image.
- [OFF]: Turns off this function.

### 4 Press $\oplus$ .

# Playing VIDEO CDs with PBC Functions (Ver.2.0)

## (PBC Playback)

### VIDEO CD

With PBC (Playback Control) functions, you can enjoy simple interactive operations, search functions, and other such operations. PBC playback allows you to play VIDEO CDs interactively by following the menu on the TV screen.

### 1 Start playing a VIDEO CD with PBC functions.

The menu for your selection appears.

### 2 Select the item number you want with the number buttons.

### 3 Press $\oplus$ .

### 4 Follow the instructions in the menu for interactive operations.

Refer to the operation details supplied with the disc, as the operating procedure may differ depending on the VIDEO CD.

## To go back to the menu

Press  $\hookrightarrow$  RETURN.

### Note

- Depending on the VIDEO CD, [Press ENTER] in Step 3 may appear as [Press SELECT] in the operating instructions supplied with the disc. In this case, press  $\triangleright$ .

### Tip

- To play without PBC, press  $\lll / \ggg$  or the number buttons while the system in stop mode to select a track, then press  $\triangleright$  or  $\oplus$ . The system starts continuous play. You cannot play still pictures such as a menu. To return to PBC playback, press  $\blacksquare$  twice, then press  $\triangleright$ .

## Tuner Functions

### Presetting Radio Stations

You can preset 20 FM stations, and 10 AM stations. Before tuning, make sure to turn down the volume to minimum.

**1** Press **FUNCTION** repeatedly until “FM” or “AM” appears in the front panel display.

**2** Press and hold **TUNING +** or **-** until the auto scanning starts.

Scanning stops when the system tunes in a station. “TUNED” and “STEREO” (for stereo program) light up in the front panel display.

**3** Press **TUNER MENU**.

**4** Press **↑/↓** repeatedly until “Memory?” appears in the front panel display.

**5** Press **+**.

A preset number appears in the front panel display.



**6** Press **↑/↓** to select the preset number you want.



#### Tip

- You can select the preset number directly by pressing the number buttons.

**7** Press **+**.

The station is stored.



**8** Press **TUNER MENU**.

**9** Repeat 1 to 8 to store other stations.

### To change the preset number

Restart from Step 3.

### To change the AM tuning interval

The AM tuning interval can be set to either 10 kHz or 9 kHz.

**1** Press **FUNCTION** repeatedly until “AM” appears in the front panel display.

**2** Press **TUNER MENU**.

**3** Press **↑/↓** repeatedly until “AM Step?” appears in the front panel display, then press **+** or **→**.

“9k → 10k” or “10k → 9k” appears in the front panel display.

**4** Press **+**.

“Complete!” appears in the front panel display. The AM tuning interval is changed.

**5** Press **TUNER MENU**.

#### Note

- If you change the interval, AM preset stations will be erased.



# Listening to the Radio

Preset radio stations in the system's memory first (see "Presetting Radio Stations" (page 64)).

- 1 Press **FUNCTION** repeatedly until "FM" or "AM" appears in the front panel display.

The last received station is tuned in.

- 2 Press **PRESET +** or **-** repeatedly to select the preset station you want.

Each time you press the button, the system tunes in one preset station.

#### Tip

- You can select the preset number directly by pressing the number buttons.

- 3 Adjust the volume by pressing **VOLUME +/-**.

## To turn off the radio

Press **I/O** to turn off the system.

To change to another function, press **FUNCTION**.

## To listen to non-preset radio stations

Use manual or automatic tuning in Step 2.

For manual tuning, press **TUNING +** or **-** repeatedly.

For automatic tuning, press and hold **TUNING +** or **-**. The automatic tuning stops automatically when the system receives the radio station. To stop the automatic tuning manually, press **TUNING +** or **-**.

## To listen to radio stations when you know the frequencies

Use direct tuning in Step 2.

- 1 Press **DIRECT TUNING**.
- 2 Press the number buttons to select the frequency number you want to listen to.
- 3 Press **+**.

#### Tip

- To improve reception, reorient the supplied antennas (aerials).

## If an FM program is noisy

If an FM program is noisy, you can select monaural reception. There will be no stereo effect, but reception will improve.

- 1 Press **TUNER MENU**.
- 2 Press **↑/↓** repeatedly until "FM Mode?" appears in the front panel display, then press **+** or **→**.
- 3 Press **↑/↓** to select "MONO."  
The default setting is underlined.
  - "STEREO": stereo reception.
  - "MONO": monaural reception.
- 4 Press **+**.  
The setting is made.
- 5 Press **TUNER MENU**.

## Naming preset stations

You can enter a name for preset stations. These names (for example, "XYZ") appear in the system's front panel display when a station is selected.

Note that no more than one name can be entered for each preset station.

- 1 Press **FUNCTION** repeatedly until "FM" or "AM" appears in the front panel display.  
The last received station is tuned in.
- 2 Press **PRESET +** or **-** repeatedly to select the preset station you want to create an index name for.
- 3 Press **TUNER MENU**.
- 4 Press **↑/↓** repeatedly until "Name In?" appears in the front panel display.



The image shows a digital display with the text "Name In?" in a large, pixelated font. Above the text, the words "TUNED" and "STEREO" are displayed in smaller, spaced-out characters. The display is framed by a thin border.

- 5 Press **+**.
- 6 Create a name by using the cursor buttons.  
Press **↑/↓** to select a character, then press **→** to move the cursor to the next position.  
Letters, numbers, and other symbols can be input for a radio station name.

## If you make a mistake

Press ←/→ repeatedly until the character to be changed flashes, then press ↑/↓ to select the desired character.

To erase the character, press ←/→ repeatedly until the character to be erased flashes, then press CLEAR.

## 7 Press ⊕.

“Complete!” appears in the front panel display, and the station name is stored.

## 8 Press TUNER MENU.

### Tip

- You can check the frequency by pressing DISPLAY repeatedly (page 66).

---

## Viewing the station name or frequency in the front panel display

When the system is set to “FM” or “AM,” you can check the frequency using the front panel display.

### Press DISPLAY.

Each time you press DISPLAY, the display changes as shown.

- ① Station name\*
- ② Frequency\*\*

\* This is displayed if you have entered a name for a preset station.

\*\* Returns to the original display when several seconds have elapsed.

## Other Operations

# Controlling the TV with the Supplied Remote

By adjusting the remote signal, you can control your TV with the supplied remote.

### Note

- When you replace the batteries of the remote, the code number may reset itself to the default (SONY) setting. Reset the appropriate code number.

## Controlling TVs with the remote

**Press and hold TV I/⏻ while entering your TV's manufacturer's code (see the table) using the number buttons. Then release TV I/⏻.**

If you successfully set the manufacturer's code, the TV mode indicator flashes twice slowly. If the setting is unsuccessful, the TV mode indicator flashes five times quickly.

## Code numbers of controllable TVs

If more than one code number is listed, try entering them one at a time until you find the one that works with your TV.

### TV

Manufacturer	Code number
SONY	501 (default), 502
ADMIRAL	510, 535, 542
AIWA	501, 536, 539
AKAI	503
AOC	503
BCL&HOWELL	535, 542
BROKSONIC	503
CROSLEX	518
CURTIS-MATHES	503, 551, 566, 567
DAEWOO	503, 504, 505, 506, 507, 515
DAYTRON	517
EMERSON	503, 517
FISHER	508, 545
FUJITSU	528

Manufacturer	Code number
FUNAI	548
GENERAL ELECTRIC	503, 509, 510
GOLDSTAR/LG	503, 512, 515, 517, 568, 576
GRUNDIG	511, 533
HITACHI	503, 513, 514, 515, 517, 557
ITT/NOKIA	521, 522
J.C.PENNY	503, 510, 566
JVC	516, 552
KTV	503, 517
LOEWE	515, 556
LXI (Sears)	503, 508, 510, 517, 518, 551
MAGNAVOX	503, 515, 517, 518, 566
MARANTZ	527
MITSUBISHI/MGA	503, 519, 527, 566, 568
NEC	503, 520, 527, 554
PANASONIC	509, 524, 553, 572
PHILCO	503, 504, 514, 517, 518
PHILIPS	515, 518, 557
PIONEER	509, 525, 526, 551, 555
PORTLAND	503
QUASAR	509, 535
RADIO SHACK	503, 510, 527, 565, 567
RCA/PROSCAN	503, 510, 523, 529
SAMSUNG	503, 515, 517, 531, 532, 534, 556, 557, 566, 569, 574
SANYO	508, 545, 546, 567
SCOTT	503, 566
SHARP	517, 535, 550, 565
SIGNATURE	535, 542, 550
SYLVANIA	503, 518, 566
TELEFUNKEN/SABA	530, 537, 538, 547, 549, 558
THOMSON	530, 537, 547, 549
TOSHIBA	535, 539, 540, 541, 551
VIDECH	503, 514
WARDS	503, 517, 566
ZENITH	542, 543, 567

## CATV

Manufacturer	Code number
SONY	802, 821, 822, 823, 824, 825, 865
AMSTRAD	845, 846
BSKYB	862
GRUNDIG	859, 860
HAMLIN/REGAL	836, 837, 838, 839, 840
HUMAX	846, 847
JERROLD	830, 831
JERROLD/GI	806, 807, 808, 809, 810, 811, 812, 813, 814
MOTOROLA	807, 819
NOKIA	851, 853, 854, 864
OAK	841, 842, 843
PACE	848, 849, 850, 852, 862, 863, 864
PANASONIC	816, 826, 833, 834, 835, 855
PHILIPS	830, 831, 856, 857, 858, 859, 860, 864
PIONEER	828, 829
SCIENTIFIC ATLANTA	815, 816, 817, 844
THOMSON	830, 831, 857, 861, 864, 876
ZENITH	826, 827

## To control the TV

You can control the TV by using following buttons.

By pressing	You can
TV I/⏻	Turn the TV on or off.
TV INPUT	Switch the TV's input source between the TV and other input sources.
VOLUME +/-*	Adjust the TV volume.
TV CH +/-	Select the TV channel.
Number buttons*, ENTER*	Select the TV channel.
TOOLS*	Displays the operation menu for the current display.
RETURN*	Return to the previous display.
TV MENU*	Display the menu of the TV.
←/↑/↓/→*, ⊕ *	Select the item on the menu.

\* To use these buttons while in the TV mode (the TV mode indicator lights up), press the TV button.

-/- is for selecting a channel number greater than 10. (For example, for channel 25, press -/-, then 2 and 5.)

### Note

- Depending on the TV, you may not be able to control your TV or to use some of the buttons above.
- The TV mode turns off when you do not operate the remote about 30 seconds.



## Changing the Brightness of the Front Panel Display

The brightness of the front panel display and soft-touch buttons can be set to either of 2 levels.

### Press DIMMER.

Each time you press DIMMER, the brightness of the front panel display and soft-touch buttons changes. The default setting is underlined.

- “DIMMER OFF”: Bright.
- “DIMMER ON”: The front panel display and soft-touch buttons become dark.

## Changing the Display Appearance of the Soft-touch Buttons

### (ILLUMINATION MODE)

You can select the way of displaying the soft-touch buttons located on the top of the unit.

- 1 Press SYSTEM MENU.**
- 2 Press  $\uparrow/\downarrow$  repeatedly until “ILLUMINATION MODE” appears in the front panel display, then press  $\oplus$  or  $\rightarrow$ .**

- 3 Press  $\uparrow/\downarrow$  to select a setting.**

The default setting is underlined.

- “STANDARD”: sets the soft-touch buttons lit up always.
- “SIMPLE”: sets the soft-touch buttons lit up when you touch them. The soft-touch buttons turn off if you do not touch them for about 10 seconds.

- 4 Press  $\oplus$ .**

The setting is made.

- 5 Press SYSTEM MENU.**

The system menu turns off.

#### Note

- When the soft-touch buttons turn off in “SIMPLE” mode, first touch the soft-touch button area so that the soft-touch buttons light up, then operate the system with them.

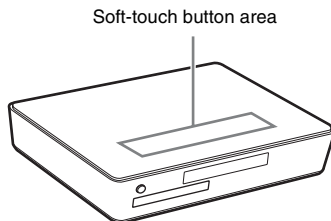

## Using the DIGITAL MEDIA PORT Adapter

The DIGITAL MEDIA PORT (DMPORT) adapter is for enjoying sound from a portable audio source or computer. By connecting a DIGITAL MEDIA PORT adapter, you can enjoy sound from the connected component on the system.

The DIGITAL MEDIA PORT adapter (TDM-BT1, Bluetooth adapter) is supplied. For details, see the operating instructions of TDM-BT1.

Also, you can use other type of DIGITAL MEDIA PORT adapter.

Available DIGITAL MEDIA PORT adapters vary in each area.

For details on connecting the DIGITAL MEDIA PORT adapter, see “Other Components Hookup” (page 25).

### Note

- Connect the supplied DIGITAL MEDIA PORT adapter (TDM-BT1) to the DMPORT1 jack on the unit. Connect the other DIGITAL MEDIA PORT adapter to the DMPORT2 jack on the unit.
- Do not connect an adaptor other than the DIGITAL MEDIA PORT adapter.
- Do not connect or disconnect the DIGITAL MEDIA PORT adapter to/from the unit while the system is turned on.
- Wait a moment after turning on the system, then operate the DIGITAL MEDIA PORT adapter.
- Depending on the type of DIGITAL MEDIA PORT adapter (not supplied), images may also be output. In this case, the system outputs a composite video signal only regardless of the type of video signal.

## Playing the connected component on the system

- 1** Press **FUNCTION** repeatedly until “DMPORT1” or “DMPORT2” appears in the front panel display.

- 2** Start playback of the connected component.

The sound and images from the connected component are played on the system or connected TV.

For operation details of the supplied DIGITAL MEDIA PORT adapter (TDM-BT1), see the operating instructions of the TDM-BT1. For operation details of the other DIGITAL MEDIA PORT adapter (not supplied), see the operating instructions of each adapter.

### Tip

- When listening to MP3 or other compressed music using a portable audio source, you can enhance the sound. Press **SOUND FIELD** repeatedly until “AUTO” or “P.AUDIO” appears in the front panel display. To cancel, select “2CH STEREO.”

### Note

- Depending on the type of DIGITAL MEDIA PORT adapter (not supplied), you may be able to operate a connected component using either the buttons on the remote or the control unit. The following illustration shows an example of buttons that can be used in this case.

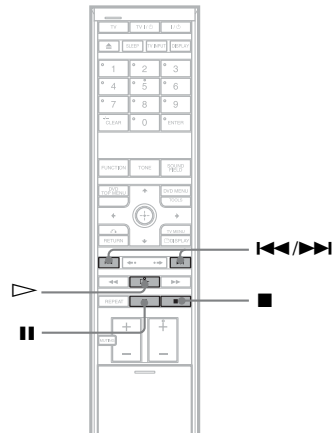

## Advanced Settings and Adjustments

### Locking Discs

#### (CUSTOM PARENTAL CONTROL, PARENTAL CONTROL)

DVD-V

VIDEO CD

Super Audio CD

C D

You can set two kinds of playback restrictions for the desired disc.

- Custom Parental Control

You can set playback restrictions so that the system will not play inappropriate discs.

- Parental Control

Playback of some DVD VIDEOS can be limited according to a predetermined level such as the age of the users. Scenes may be blocked or replaced with different scenes.

The same password is used for both Custom Parental Control and Parental Control.

### Preventing playback of specific discs [CUSTOM PARENTAL CONTROL]

You can set the same Custom Parental Control password for up to 40 discs. When you set the 41st-disc, the first disc is canceled.

#### 1 Insert the disc you want to lock.

If the disc is playing, press ■ to stop playback.

#### 2 Press DISPLAY while the system is in stop mode.

The Control Menu display appears.

#### 3 Press to select [PARENTAL CONTROL], then press .

The options for [PARENTAL CONTROL] appear.

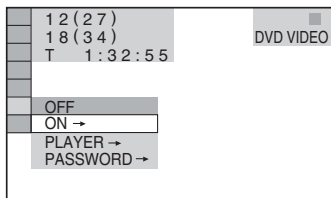

#### 4 Press to select [ON ->], then press .

##### ■ If you have not entered a password

The display for registering a new password appears.

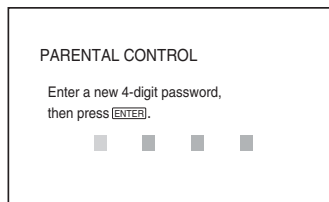

Enter a 4-digit password using the number buttons, then press .

The display for confirming the password appears.

##### ■ When you have already registered a password

The display for entering the password appears.

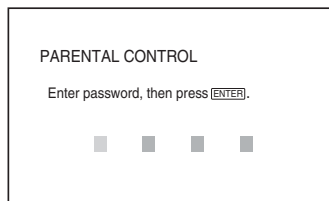

#### 5 Enter or re-enter your 4-digit password using the number buttons, then press .

[Custom parental control is set.] appears and the TV screen returns to the Control Menu display.

### To turn off the Custom Parental Control function

#### 1 Follow steps 1 through 3 of “Preventing playback of specific discs [CUSTOM PARENTAL CONTROL].”

#### 2 Press to select [OFF ->], then press .

#### 3 Enter your 4-digit password using the number buttons, then press .



## To play a disc for which Custom Parental Control is set

- 1 Insert the disc for which Custom Parental Control is set.  
The [CUSTOM PARENTAL CONTROL] display appears.

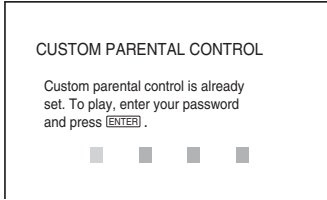

- 2 Enter your 4-digit password using the number buttons, then press  $\oplus$ .  
The system is ready for playback.

### Tip

- If you forget your password, enter the 6-digit number "199703" using the number buttons when the [CUSTOM PARENTAL CONTROL] display asks you for your password, then press  $\ominus$ . The display will ask you to enter a new 4-digit password.

## Limiting playback for children [PARENTAL CONTROL] (DVD only)

Playback of some DVD VIDEOS can be limited according to a predetermined level such as the age of the users. The [PARENTAL CONTROL] function allows you to set a playback limitation level.

- 1 Press  $\text{[DISPLAY]}$  while the system is in stop mode.  
The Control Menu display appears.

- 2 Press  $\uparrow/\downarrow$  to select  [PARENTAL CONTROL], then press  $\oplus$ .  
The options for [PARENTAL CONTROL] appear.

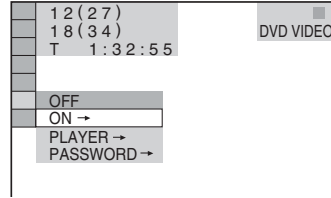

- 3 Press  $\uparrow/\downarrow$  to select [PLAYER  $\rightarrow$ ], then press  $\oplus$ .  
  - If you have not entered a password  
The display for registering a new password appears.

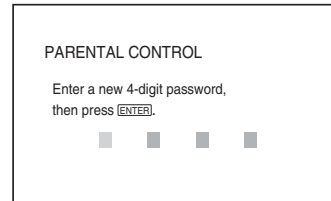

Enter a 4-digit password using the number buttons, then press  $\oplus$ .  
The display for confirming the password appears.

- When you have already registered a password  
The display for entering the password appears.

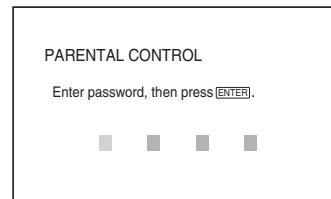

**4** Enter or re-enter your 4-digit password using the number buttons, then press  $\oplus$ .

The display for setting the playback limitation level appears.

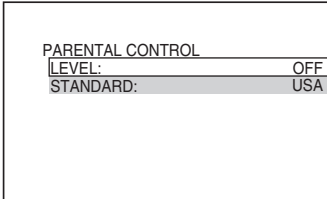

**5** Press  $\uparrow/\downarrow$  to select [STANDARD], then press  $\oplus$ .

The selection items for [STANDARD] are displayed.

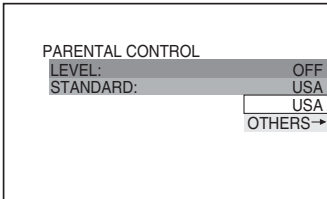

**6** Press  $\uparrow/\downarrow$  to select a geographic area as the playback limitation level, then press  $\oplus$ .

The area is selected.

When you select [OTHERS →], select and enter a standard code in the table of “Parental Control Area Code List” (page 95) using the number buttons.

**7** Press  $\uparrow/\downarrow$  to select [LEVEL], then press  $\oplus$ .

The selection items for [LEVEL] are displayed.

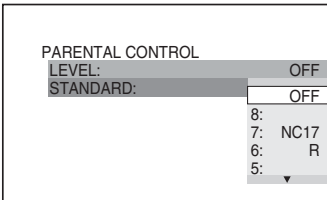

**8** Press  $\uparrow/\downarrow$  to select the level you want, then press  $\oplus$ .

Parental Control setting is complete.

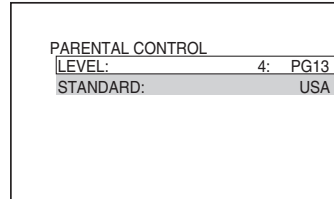

The lower the value, the stricter the limitation.

**To turn off the Parental Control function**

Set [LEVEL] to [OFF] in Step 8.

**To play a disc for which Parental Control is set**

**1** Insert the disc and press  $\triangleright$ .

The display for entering your password appears.

**2** Enter your 4-digit password using the number buttons, then press  $\oplus$ .

The system starts playback.









**Tip**

- If you forget your password, remove the disc and repeat steps 1 to 3 of “Preventing playback of specific discs [CUSTOM PARENTAL CONTROL].” When you are asked to enter your password, enter “199703” using the number buttons, then press  $\oplus$ . The display will ask you to enter a new 4-digit password. After you enter a new 4-digit password, replace the disc in the unit and press  $\triangleright$ . When the display for entering your password appears, enter your new password.



**Note**

- When you play discs which do not have the Parental Control function, playback cannot be limited on this system.
- Depending on the disc, you may be asked to change the parental control level while playing the disc. In this case, enter your password, then change the level. If the Resume Play mode is canceled, the level returns to the previous level.

## Changing the password

- 1** Press  **DISPLAY** while the system is in stop mode.  
The Control Menu display appears.
- 2** Press  to select  [PARENTAL CONTROL], then press .
- 3** Press  to select [PASSWORD →], then press .
- 4** Enter your 4-digit password using the number buttons, then press .
- 5** Enter a new 4-digit password using the number buttons, then press .
- 6** To confirm your password, re-enter it using the number buttons, then press .

### If you make a mistake entering your password

Press  before you press  and input the correct number.

## Calibrating the Appropriate Settings Automatically

### (AUTO CALIBRATION)

D. C. A. C.\* can set the appropriate surround sound automatically.

\* Digital Cinema Auto Calibration

#### Note

- Loud test sound is output when [AUTO CALIBRATION] starts. You cannot turn the volume down. Give consideration to children and neighbor.
- The A.CAL MIC jack is for the supplied calibration mic only. Do not connect other mics as it may cause damage to the system.

- 1** Connect the calibration mic to the **A.CAL MIC jack on the rear panel, and set it up at the ear level using a tripod, etc. (not supplied).**

The front of each speaker should face the calibration mic, and there should be no obstruction between the speakers and the calibration mic.

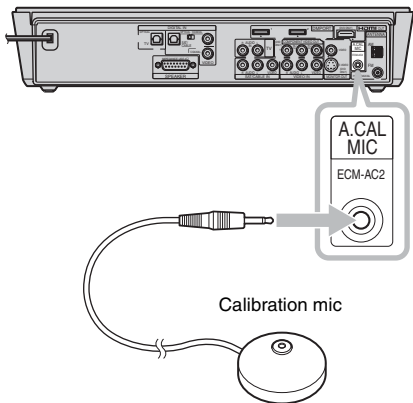

**Side view**

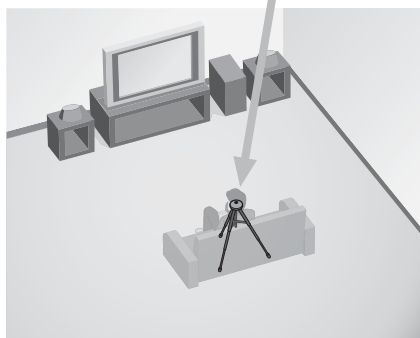

- 2** Press **FUNCTION** repeatedly until “DVD” appears in the front panel display.
- 3** Press **DISPLAY** when the system is in stop mode.  
The Control Menu display appears.
- 4** Press **↑/↓** to select **[AUTO CALIBRATION]**, then press **+**.

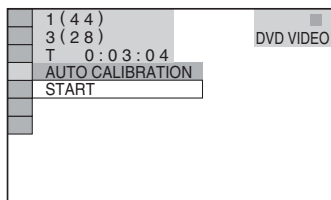

**5** Press **+**.

The **[AUTO CALIBRATION]** display appears.

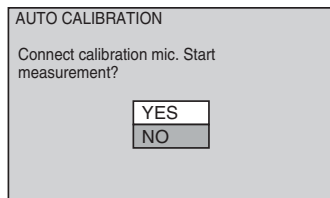

**6** Press **↑/↓** to select **[YES]**, then press **+** to start the auto calibration.

Be quiet during the measurement.

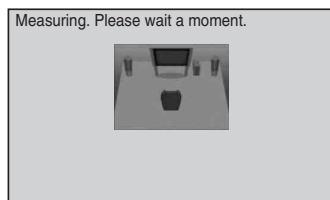

**Note**

- Avoid being in the measurement area and making noise during the measurement (about 1 minute), to avoid measurement failure. During the measurement, test signals are output from the speakers.
- The environment of the room in which the system is installed may affect measurements.
- If an error message appears, follow the message, then select **[YES]**.  
An error message appears when:
  - the calibration mic is not connected.
  - front speakers are not correctly connected.
  - subwoofer is not connected.

**7** Press **←/↑/↓/→** to select **[YES]** or **[NO]**, then press **+**.

### ■ The measurement is OK.

Unplug the calibration mic, then select [YES]. The result is implemented.

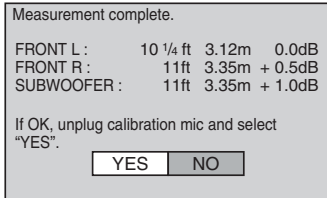

### ■ The measurement is not OK.

Follow the message, then select [YES] to retry.

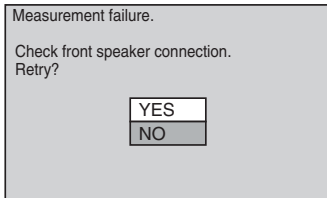

#### Note

- While the Auto Calibration function works:
  - do not turn off the power.
  - do not press any button.
  - do not change the volume.
  - do not change the function.
  - do not load or eject a disc.
  - do not unplug the calibration mic.
- Depending on the acoustics of the room, the displayed distance may not represent the actual distance.

## To select the auto calibration setting mode

You can select the auto calibration setting mode.

- 1 Press SYSTEM MENU.
- 2 Press  $\uparrow/\downarrow$  repeatedly until "A.CAL MODE" appears in the front panel display, then press  $\oplus$  or  $\rightarrow$ .
- 3 Press  $\uparrow/\downarrow$  to select a setting.

The default setting is underlined.

- "A.CAL ON": reflects the setting that is set by the auto calibration.
- "A.CAL OFF": returns to the default speaker setting, regardless of the speaker setting made by the auto calibration function.

- 4 Press  $\oplus$ .

- 5 Press SYSTEM MENU.

The system menu turns off.

#### Note

- If "Setup A.CAL" appears in the front panel display, perform [AUTO CALIBRATION]. For details, see page 75.
- When you perform [AUTO CALIBRATION], "A.CAL MODE" is set to "A.CAL ON" automatically.

## To adjust the subwoofer level

- 1 Press SYSTEM MENU.

- 2 Press  $\uparrow/\downarrow$  repeatedly until "SW LEVEL" appears in the front panel display, then press  $\oplus$  or  $\rightarrow$ .

- 3 Press  $\uparrow/\downarrow$  to adjust.

Adjusts the subwoofer level (–6.0 dB – +6.0 dB, 0.5 dB increments).

The adjusted value appears in the front panel display.

- 4 Press  $\oplus$ .

- 5 Press SYSTEM MENU.

The system menu turns off.

#### Note

- When you perform [AUTO CALIBRATION], the subwoofer level setting is readjusted.

## Using the Setup Display

By using the Setup Display, you can make various adjustments to items such as picture and sound.

For an overall list of Setup Display items, see page 103.

### Note

- Playback settings stored in the disc take priority over the Setup Display settings and not all the functions described may work.

- 1 Press **FUNCTION** repeatedly until “DVD” appears in the front panel display.
- 2 Press **DISPLAY** when the system is in stop mode.  
The Control Menu display appears.
- 3 Press **↑/↓** to select  [SETUP], then press **+**.  
The options for [SETUP] appear.

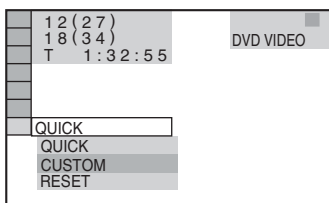

- 4 Press **↑/↓** to select [CUSTOM], then press **+**.  
The Setup Display appears.

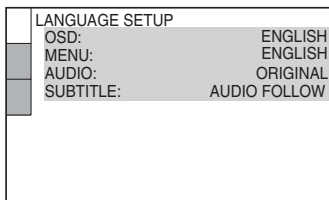

- 5 Press **↑/↓** to select the setup item from the displayed list: [LANGUAGE SETUP], [SCREEN SETUP], or [CUSTOM SETUP]. Then press **+**.  
The Setup item is selected.

Example: [SCREEN SETUP]

Selected item

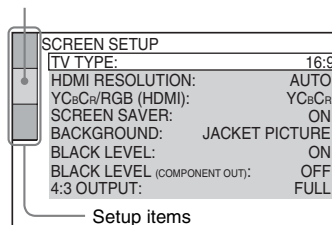

- 6 Select an item using **↑/↓**, then press **+**.  
The options for the selected item appear.  
Example: [TV TYPE]

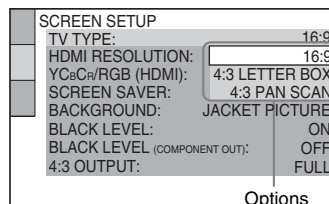

- 7 Select a setting using **↑/↓**, then press **+**.  
The setting is selected and setup is complete.

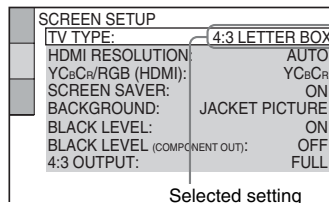

## To reset all of the [SETUP] settings

- 1 Select [RESET] in Step 4 and press  $\oplus$ .
- 2 Select [YES] using  $\uparrow/\downarrow$ .  
You can also quit the process and return to the Control Menu display by selecting [NO] here.
- 3 Press  $\oplus$ .  
All the settings explained on pages 79 to 83 return to the default settings. Do not press  $\mathbb{I}/\mathbb{O}$  while resetting the system as it takes a few seconds to complete.

### Note

- When you turn the system on after resetting and no disc is in the unit, the guide message appears on the TV screen. To perform the Quick Setup (page 18), press  $\oplus$ , to return to normal screen, press CLEAR.
- “BASS,” “TREBLE,” (page 33) and “SW LEVEL” (page 77) settings are also returned to the default.

## Setting the Display or Sound Track Language

### [LANGUAGE SETUP]

[LANGUAGE SETUP] allows you to set various languages for the on-screen display or sound track.

Select [LANGUAGE SETUP] in the Setup Display. To use the display, see “Using the Setup Display” (page 78).

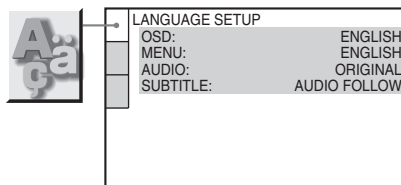

### ■ [OSD] (On-Screen Display)

Switches the display language on the screen.

### ■ [MENU] (DVD VIDEO only)

You can select the desired language for the disc's menu.

### ■ [AUDIO] (DVD VIDEO only)

Switches the language of the sound track. When you select [ORIGINAL], the language given priority in the disc is selected.

### ■ [SUBTITLE] (DVD VIDEO only)

Switches the language of the subtitle recorded on the DVD VIDEO. When you select [AUDIO FOLLOW], the language for the subtitles changes according to the language you selected for the sound track.

### Tip

- If you select [OTHERS  $\rightarrow$ ] in [MENU], [AUDIO], and [SUBTITLE], select and enter a language code from “Language Code List” (page 95) using the number buttons.

### Note

- When you select a language in [MENU], [AUDIO], or [SUBTITLE] that is not recorded on the DVD VIDEO, one of the recorded languages will be automatically selected (depending on the disc, the language may not be selected automatically).

# Settings for the Display

## [SCREEN SETUP]

Choose settings according to the TV to be connected.

Select [SCREEN SETUP] in the Setup Display. To use the display, see “Using the Setup Display” (page 78).

The default settings are underlined.

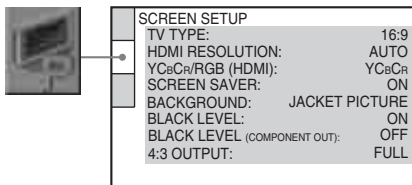

### ■ [TV TYPE]

Selects the aspect ratio of the connected TV (4:3 standard or wide).

**[16:9]** Select this when you connect a wide-screen TV or a TV with a wide mode function.

**[4:3 LETTER BOX]** Select this when you connect a 4:3 screen TV. Displays a wide picture with bands on the upper and lower portions of the screen.

**[4:3 PAN SCAN]** Select this when you connect a 4:3 screen TV. Automatically displays the wide picture on the entire screen and cuts off the portions that do not fit.

[16:9]

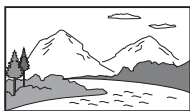

[4:3 LETTER BOX]



[4:3 PAN SCAN]

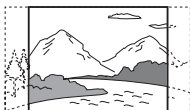

### Note

- Depending on the DVD, [4:3 LETTER BOX] may be selected automatically instead of [4:3 PAN SCAN] or vice versa.

### ■ [HDMI RESOLUTION]

Selects the type of video signals output from the HDMI OUT (high-definition multimedia interface out) jack. When you select [AUTO] (default), the system outputs video signals of the highest resolution acceptable for your TV.

If the picture is not clear, natural or to your satisfaction, try another option that suits the disc and your TV/projector, etc. For details, refer also to the instruction manual supplied with the TV/projector, etc.

**[AUTO]** Normally, select this.

**[1920 × 1080i\*]** Sends 1920 × 1080i video signals.

**[1280 × 720p\*]** Sends 1280 × 720p video signals.

**[720 × 480p\*]** Sends 720 × 480p video signals.

\* i: interlace, p: progressive

### Note

- Even when a setting other than [AUTO] is selected and the connected TV cannot accept the resolution, the system automatically adjusts the video signals that are suitable for the TV.
- When the HDMI indicator on the front panel lights up, images other than [720 × 480p] are stretched vertically.

### ■ [YCbCr/RGB (HDMI)]

Selects the type of HDMI signal output from HDMI OUT jack.

**[YCbCr]** Outputs YCbCr signals.

**[RGB]** Outputs RGB signals.

### Note

- If the playback picture becomes distorted, set [YCbCr] to [RGB].
- If the HDMI OUT jack is connected to equipment with a DVI jack, [RGB] signals will be automatically output even when you select [YCbCr].



## ■ [SCREEN SAVER]

The screen saver image appears when you leave the system in pause or stop mode for 15 minutes, or when you play back a Super Audio CD, CD, DATA CD (MP3 audio), or DATA DVD for more than 15 minutes. The screen saver will help prevent your display device from becoming damaged (ghosting). Press any button (e.g.,  button) to cancel the screen saver.

**[ON]** Turns on the screen saver.

**[OFF]** Turns off the screen saver.

## ■ [BACKGROUND]

Selects the background color or picture on the TV screen in stop mode or while playing a Super Audio CD, CD, DATA CD (MP3 audio), or DATA DVD.

**[JACKET PICTURE]** The jacket picture (still picture) appears, but only when the jacket picture is already recorded on the disc (CD-EXTRA, etc.). If the disc does not contain a jacket picture, the [GRAPHICS] picture appears.

**[GRAPHICS]** A preset picture stored in the system appears.

**[BLUE]** The background color is blue.

**[BLACK]** The background color is black.

## ■ [BLACK LEVEL]

Selects the black level (setup level) for the video signals output from the jacks other than COMPONENT VIDEO OUT/HDMI OUT.

**[ON]** Sets the black level of the output signal to the standard level.

**[OFF]** Lowers the standard black level. Use this when the picture becomes too white.

## ■ [BLACK LEVEL (COMPONENT OUT)]

Selects the black level (setup level) for the video signals output from the COMPONENT VIDEO OUT jacks.

You cannot select this and the setting is not effective when the system outputs progressive signal.

**[OFF]** Sets the black level of the output signal to the standard level.

**[ON]** Raise the standard black level. Use this when the picture becomes too black.

## ■ [4:3 OUTPUT]

This setting is effective only when you set [TV TYPE] in [SCREEN SETUP] to [16:9] (page 80). Adjust to watch 4:3 aspect ratio progressive signals. If you can change the aspect ratio on your progressive format (525p/625p) compatible TV, change the setting on your TV, not the system. Note that this setting is effective only for HDMI connection or progressive signals output from the COMPONENT VIDEO OUT jacks.

### Note

- This setting is effective only when "P AUTO" (PROGRESSIVE AUTO) or "P VIDEO" (PROGRESSIVE VIDEO) is selected by using RESOLUTION (page 23).

**[FULL]** Select this when you can change the aspect ratio on your TV.

**[NORMAL]** Select this when you cannot change the aspect ratio on your TV. Shows a 16:9 aspect ratio signal with black bands on left and right sides of the image.

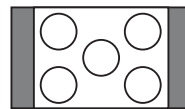

16:9 aspect ratio TV

# Custom Settings

## [CUSTOM SETUP]

Use this to set up playback related and other settings.

Select [CUSTOM SETUP] in the Setup Display. To use the display, see “Using the Setup Display” (page 78).

The default settings are underlined.

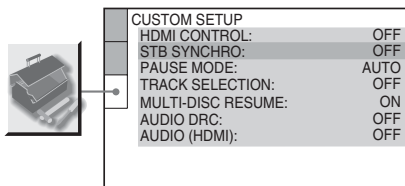

### ■ [HDMI CONTROL]

Switches the HDMI CONTROL function on or off. This function is available when you connect the system and TV with the HDMI cable. For details, see “Preparing for the HDMI CONTROL function” (page 36).

**[OFF]** Sets the [HDMI CONTROL] function to off.

**[ON]** Sets the [HDMI CONTROL] function to on. You can operate mutually between components that are connected with the HDMI cable.

#### Note

- When you set to [ON] without the HDMI connection of the TV, [Please verify the HDMI connection.] appears and you cannot set to [ON].

### ■ [STB SYNCHRO]

Switches the STB SYNCHRO function on or off. This function is available when you connect the system and TV with the HDMI cable and you set [HDMI CONTROL] to [ON]. For details, see “Preparing for the HDMI CONTROL function” (page 36).

**[OFF]** Sets the [STB SYNCHRO] function to off.

**[ON]** Sets the [STB SYNCHRO] function to on.

#### Note

- This function is available only when you set [HDMI CONTROL] to [ON].

### ■ [PAUSE MODE] (DVD VIDEO/DVD-R/ DVD-RW only)

Selects the picture in pause mode.

**[AUTO]** The picture, including subjects that move dynamically, is output with no jitter. Normally select this position.

**[FRAME]** The picture, including subjects that do not move dynamically, is output in high resolution.

### ■ [TRACK SELECTION] (DVD VIDEO only)

Gives the sound track which contains the highest number of channels priority when you play a DVD VIDEO on which multiple audio formats (PCM, DTS, MPEG audio, or Dolby Digital format) are recorded.

**[OFF]** No priority given.

**[AUTO]** Priority given.

#### Note

- When you set the item to [AUTO], the language may change. The [TRACK SELECTION] setting has higher priority than the [AUDIO] settings in [LANGUAGE SETUP] (page 79). (Depending on the disc, this function may not work.)
- If PCM, DTS, Dolby Digital sound, and MPEG audio tracks have the same number of channels, the system selects PCM, DTS, Dolby Digital sound, and MPEG audio tracks in this order.

### ■ [MULTI-DISC RESUME] (DVD VIDEO/ VIDEO CD only)

Switches the Multi-disc Resume setting on or off.

**[ON]** Stores the resume settings in memory.

**[OFF]** Does not store the resume settings in memory. Playback restarts at the resume point only for the current disc in the system.

### ■ [AUDIO DRC] (DVD VIDEO only)

Narrows the dynamic range of the sound track. Useful for watching movies at low volume late at night.

[OFF]	No compression of dynamic range.
[STANDARD]	Reproduces the sound track with the kind of dynamic range that the recording engineer intended.
[MAX]	Compresses dynamic range fully.

### ■ [AUDIO (HDMI)]

Selects the type of audio signal output from the HDMI OUT jack.

[OFF]	The sound is not output from the HDMI OUT jack.
[AUTO]	Outputs audio signals that is matched to the requested audio stream from the connected TV.
[PCM]	Converts Dolby Digital, DTS (digital theater system), or 96 kHz/24 bit PCM (pulse code modulation) signals to 48 kHz/ 16 bit PCM (pulse code modulation).

#### Note

- A loud noise (or no sound) will be output if you connect the system to a TV that is not compatible with DOLBY DIGITAL/DTS (digital theater system) signals and [AUTO] is selected. In this case, select [PCM].
- When you connect the system and TV with the HDMI cable and [AUTO] or [PCM] is selected, AUDIO DRC, A/V SYNC, TONE, MOVIE/MUSIC, and sound field are not applied to the sound that is output from the TV.

## Returning to the Default Settings

### Returning the settings on the Setup Display to the default

**1** Select [RESET] in Step 4 of “Using the Setup Display” (page 78) and press ⊕.

**2** Select [YES] using ↑/↓.

You can also quit the process and return to the Control Menu by selecting [NO] here.

**3** Press ⊕.

All the settings explained on pages 79 to 83 return to the default settings. Do not press I/⏻ while resetting the system as it takes a few seconds to complete.

#### Note

- When you turn the system on after resetting and no disc is in the unit, the guide message appears on the TV screen. To perform the Quick Setup (page 18), press ⊕, to return to normal screen, press CLEAR.
- “BASS,” “TREBLE,” (page 33) and “SW LEVEL” (page 77) settings are also returned to the default.

### Returning the sound field settings or radio settings to the default

**1** Turn off the power.

**2** Press and hold I/⏻ on the unit about 5 seconds.

“MEMORY CLR” and “PUSH POWER” appear alternately in the front panel display about 10 seconds.

**3** Press I/⏻.

“CLEARING” appears in the front panel display and the default settings are returned. After “CLEARED!” appears, the system is turned off.

#### Note

- In Step 3, if you do not press I/⏻ or press any buttons other than I/⏻ on the unit, the system turns on. The setting is not made.

## Additional Information

### Precautions

#### On power sources

- Unplug the unit from the wall outlet if you do not intend to use it for an extended period of time. To disconnect the cord, pull it out by the plug, never by the cord.

#### On placement

- Place the system in a location with adequate ventilation to prevent heat build-up in the system.
- At high volume, over long periods of time, the cabinet becomes hot to the touch. This is not a malfunction. However, touching the cabinet should be avoided. Do not place the unit in a confined space where ventilation is poor as this may cause overheating.
- Do not block the ventilation slots by putting anything on the system. The system is equipped with a high power amplifier. If the ventilation slots are blocked, the unit can overheat and malfunction.
- Do not place the unit on surfaces (rugs, blankets, etc.) or near materials (curtains, draperies) that may block the ventilation slots.
- Do not install the unit near heat sources such as radiators, or air ducts, or in a place subject to direct sunlight, excessive dust, mechanical vibration, or large loudspeakers.
- Keep the unit and discs away from equipment with strong magnets, such as microwave ovens, or large loudspeakers.
- Do not place anything on the top panel of the unit. Do not place heavy objects on the unit as it may be damaged.
- Do not install the unit in an inclined position. It is designed to be operated in a horizontal position only.

#### On operation

- If the system is brought directly from a cold to a warm location, or is placed in a very damp room, moisture may condense on the lenses inside the system. Should this occur, the system may not operate properly. In this case, remove the disc and leave the system turned on for about half an hour until the moisture evaporates.
- When you move the system, take out any disc. If you don't, the disc may be damaged.
- If anything falls into the cabinet, unplug the unit and have it checked by qualified personnel before operating it any further.

#### On adjusting volume

- Do not turn up the volume while listening to a section with very low level inputs or no audio signals. If you do, the speakers may be damaged when a peak level section is suddenly played.

#### On cleaning

- Clean the cabinet, panel, and controls with a soft cloth slightly moistened with a mild detergent solution. Do not use any type of abrasive pad, scouring powder or solvent such as alcohol or benzene.  
If you have any questions or problems concerning your system, please consult your nearest Sony dealer.
- Clean the top panel with a soft cloth lightly. Do not wipe the top panel of the unit where there is dust or sand as it may be damaged.

#### On cleaning discs, disc/lens cleaners

- **Do not use cleaning discs or disc/lens cleaners (including wet or spray types). These may cause apparatus to malfunction.**

#### On your TV's color

- If the speakers should cause the TV screen to have color irregularity, turn off the TV then turn it on after 15 to 30 minutes. If color irregularity should persist, place the speakers farther away from the set.



#### IMPORTANT NOTICE

Caution: This system is capable of holding a still video image or on-screen display image on your television screen indefinitely. If you leave the still video image or on-screen display image displayed on your TV for an extended period of time you risk permanent damage to your television screen. Projection televisions are especially susceptible to this.

The nameplate is located on the bottom exterior of the unit.

## On moving the system

When you carry the system, use the following procedure to protect the inner mechanism.

- 1 Press  to remove a disc.  
Make sure that a disc is removed from the unit.
- 2 Press .
- 3 Press  to turn off the power.
- 4 Remove the AC power cord (mains lead) from the wall outlet (mains).

## Notes about the Discs

### On handling discs

- To keep the disc clean, handle the disc by its edge. Do not touch the surface.
- Do not stick paper or tape on the disc.



- Do not expose the disc to direct sunlight or heat sources such as hot air ducts, or leave it in a car parked in direct sunlight as the temperature may rise considerably inside the car.
- After playing, store the disc in its case.

### On cleaning

- Before playing, clean the disc with a cleaning cloth.  
Wipe the disc from the center out.



- Do not use solvents such as benzine, thinner, commercially available cleaners, or anti-static spray intended for vinyl LPs.

This system can only play back a standard circular disc. Using neither standard nor circular discs (e.g., card, heart, or star shape) may cause a malfunction.

Do not use a disc that has a commercially available accessory attached, such as a label or ring.

## Troubleshooting

If you experience any of the following difficulties while using the system, use this troubleshooting guide to help remedy the problem before requesting repairs. Should any problem persist, consult your nearest Sony dealer.

Note that if service personnel changes some parts during repair, these parts may be retained.

### Power

#### The power is not turned on.

- Check that the AC power cord (mains lead) is connected securely.
- Press **I/⏻** after all indications disappear from the front panel display.
- Check that nothing obstructs the soft-touch buttons on the unit.

#### If “PROTECTOR” and “PUSH POWER” appear alternately in the front panel display.

Press **I/⏻** to turn off the system, and check the following items after “STANDBY” disappears.

- Are you using only the specified speakers?
- Is anything blocking the ventilation slots of the system?

Check the above items and fix any problems. After “STANDBY” disappears, wait about 20 seconds before turning on the power by pressing **I/⏻**. If the cause of the problem cannot be found even after checking all the above items, consult your nearest Sony dealer.

### Picture

#### There is no picture.

- The video connecting cords are not connected securely.
- The video connecting cords are damaged.
- The unit is not connected to the correct TV input jack (page 10, 20).
- The video input on the TV is not set so that you can view pictures from the system.
- You have set progressive format but your TV cannot accept the signal in progressive format. In this case, return the setting to interlace format (the default setting) (page 23).
- Even if your TV is compatible with progressive format (525p/625p) signals, the image may be affected when you set progressive format. In this case, return the setting to interlace format (the default setting) (page 23).

- Re-connect the connecting cord securely.
- The system is connected to an input device that is not HDCP (high-bandwidth digital content protection) compliant (“HDMI” on the front panel does not light up). See page 98.

- If the HDMI OUT jack is used for video output, changing the [HDMI RESOLUTION] setting in [SCREEN SETUP] may solve the problem (page 80).

Connect the TV and the system using a video jack other than the HDMI OUT, and switch the TV’s input to the connected video input so that you can see the on-screen displays. Change the [HDMI RESOLUTION] setting in [SCREEN SETUP], and switch the TV’s input back to HDMI. If the picture still does not appear, repeat the steps and try other options.

- You have selected “P AUTO” (PROGRESSIVE AUTO) or “P VIDEO” (PROGRESSIVE VIDEO) using the RESOLUTION button on the remote (“PROGRESSIVE” lights up in the front panel display) even though your TV cannot accept the progressive signal. In this case, disconnect the HDMI cable from the unit and then select “INTERLACE” (INTERLACE) so that the “PROGRESSIVE” indicator turns off.
- If the signal from the S VIDEO OUT jack is distorted, change the [HDMI RESOLUTION] setting in [SCREEN SETUP] to [720 × 480p].

#### Picture noise appears.

- The disc is dirty or flawed.
- If the picture output from your system goes through your VCR to get to your TV, the copy-protection signal applied to some DVD programs could affect picture quality. If you still experience problems even when you connect your unit directly to your TV, try connecting your unit to your TV’s S video input (page 20).

#### Even though you set the aspect ratio in [TV TYPE] of [SCREEN SETUP], the picture does not fill the screen.

- The aspect ratio on the disc is fixed.

#### Color irregularity occurs on the TV screen.

The front speakers in this system are magnetically shielded to prevent magnetic leakage. However, some leakage may occur, as a high-strength magnet is employed. If this happens, check the following items:

- If the speakers are used with a CRT-based TV or projector, install the speakers at least 0.3 m (1.0 ft) from the TV set.
- If the color irregularity persists, turn off the TV set once, then turn it on after 15 to 30 minutes.

- If howling occurs, reposition the speakers farther away from the TV set.
- Make sure that no magnetic object (magnetic latch on a TV stand, health care device, toy, etc.) is placed near the speakers.

## Sound

### There is no sound.

- The speaker cord is not connected securely.
- Press **MUTING** on the remote if “MUTING ON” is displayed in the front panel display.
- The system is in pause mode or in Slow-motion Play mode. Press  $\triangleright$  to return to normal play mode.
- Fast forward or fast reverse is performed. Press  $\triangleright$  to return to normal play mode.
- Check the speaker settings (page 16).
- Super Audio CD audio signals are not output from the HDMI OUT jack.
- The equipment connected to the HDMI OUT jack does not conform to the audio signal format, in this case set [AUDIO (HDMI)] in [CUSTOM SETUP] to [PCM] (page 83).

### No sound is output from the HDMI OUT jack.

- Set [AUDIO (HDMI)] in [CUSTOM SETUP] to [AUTO] or [PCM] (page 83).
- The HDMI OUT jack is connected to a DVI (digital visual interface) device (DVI (digital visual interface) jacks do not accept audio signals).
- The HDMI OUT jack does not output Super Audio CD sound.
- Try the following: ① Turn the system off and on again. ② Turn the connected equipment off and on again. ③ Disconnect and then connect the HDMI cable again.

### The left and right sounds are unbalanced or reversed.

- Check that the speakers and components are connected correctly and securely.
- Perform [AUTO CALIBRATION] (page 75).

### There is no sound from the subwoofer.

- Check the speaker connections and settings (page 10, 16).

### Severe hum or noise is heard.

- Check that the speakers and components are connected securely.
- Check that the connecting cords are away from a transformer or motor, and at least 3 meters (10 ft) away from your TV set or a fluorescent light.
- Move your TV away from the audio components.

- The plugs and jacks are dirty. Wipe them with a cloth slightly moistened with alcohol.
- Clean the disc.

### The sound loses stereo effect when you play a VIDEO CD, a CD, or an MP3.

- Set the audio setting to [STEREO] by pressing **AUDIO** (page 51).
- Make sure the unit is connected properly.

### The surround effect is difficult to hear when you are playing a Dolby Digital, DTS, or MPEG audio sound track.

- Make sure the sound field is set to “AUTO” (page 32).
- Check the speaker connections and settings (page 10, 16).
- Depending on the DVD, the output signal may not be the entire 5.1 channel. It may be monaural or stereo even if the sound track is recorded in Dolby Digital or MPEG audio format.

### The beginning of the sound is cut off.

- Set the Movie/Music mode to “MOVIE” or “MUSIC” (page 31).

## Operation

### The soft-touch buttons do not function.

- Check that nothing obstructs the soft-touch buttons on the unit.

### Radio stations cannot be tuned in.

- Check that the antenna (aerial) is connected securely. Adjust the antenna (aerial) or connect an external antenna (aerial) if necessary.
- The signal strength of the stations is too weak (when tuning in with automatic tuning). Use direct tuning.
- No stations have been preset or the preset stations have been cleared (when tuning by scanning preset stations). Preset the stations (page 64).
- Press **DISPLAY** so that the frequency appears in the front panel display.

### The remote does not function.

- There are obstacles between the remote and the unit.
- The distance between the remote and the unit is too far.
- The remote is not pointed at the remote sensor on the unit.
- The batteries in the remote are weak.

### A disc does not play.

- There is no disc inserted.
- The disc is upside down.  
Insert the disc with the playback side facing down.

- The disc is skewed on the disc tray.
- The system cannot play CD-ROMs, etc. (page 6).
- The region code on the DVD does not match the system.
- Moisture has condensed inside the unit and may cause damage to the lenses. Remove the disc and leave the unit turned on for about half an hour.

---

**An MP3 audio track cannot be played.**

- The DATA CD is not recorded in an MP3 format that conforms to ISO 9660 Level 1/Level 2, or Joliet.
- The DATA DVD is not recorded in an MP3 format that conforms to UDF (Universal Disk Format).
- The MP3 audio track does not have the extension “.MP3.”
- The data is not formatted in MP3 even though it has the extension “.MP3.”
- The data is not MPEG1 Audio Layer 3 data.
- The system cannot play audio tracks in MP3PRO format.
- The [MODE (MP3, JPEG)] setting has been set to [IMAGE (JPEG)] (page 61).
- If you cannot change the [MODE (MP3, JPEG)] setting, re-load the disc or turn the system off, then on.

---

**A JPEG image file cannot be played.**

- The DATA CD is not recorded in a JPEG format that conforms to ISO 9660 Level 1/Level 2, or Joliet.
- The DATA DVD is not recorded in a JPEG format that conforms to UDF (Universal Disk Format).
- It has an extension other than “.JPEG” or “.JPG.”
- It is larger than 3,072 (width) × 2,048 (height) in normal mode, or more than 2,000,000 pixels in Progressive JPEG which is mainly used on the Internet WEB site.
- It does not fit the screen (those images are reduced).
- The [MODE (MP3, JPEG)] setting has been set to [AUDIO (MP3)] (page 61).
- If you cannot change the [MODE (MP3, JPEG)] setting, re-load the disc or turn the system off, then on.

---

**The MP3 audio tracks and JPEG image file start playing simultaneously.**

- [AUTO] has been selected in [MODE (MP3, JPEG)] (page 61).

---

**The titles of album/track/file name are not displayed correctly.**

- The system can only display numbers and letters of the alphabets. Other characters are displayed as [\*].

---

**A disc does not start playing from the beginning.**

- Program Play, Shuffle Play, or Repeat Play has been selected.  
Press CLEAR to cancel these functions before playing a disc.
- Resume Play has been selected.  
During stop, press ■ on the system or the remote and then start playback (page 46).
- The title, DVD or PBC menu automatically appears on the TV screen.

---

**The system starts playing the disc automatically.**

- The DVD features an auto playback function.

---

**Playback stops automatically.**

- Some discs may contain an auto pause signal.  
While playing such a disc, the system stops playback at the auto pause signal.

---

**You cannot perform some functions such as Stop, Search, Slow-motion Play, or Repeat Play.**

- Depending on the disc, you may not be able to perform some of the operations above. See the operating instructions that came with the disc.

---

**Messages do not appear on the screen in the language you want.**

- In the Setup Display, select the desired language for the on-screen display in [OSD] under [LANGUAGE SETUP] (page 79).

---

**The language for the sound track cannot be changed.**

- Multilingual tracks are not recorded on the DVD being played.
- The DVD prohibits changing the language for the sound track.

---

**The subtitle language cannot be changed.**

- Multilingual subtitles are not recorded on the DVD being played.
- The DVD prohibits changing the subtitles.

---

**The subtitles cannot be turned off.**

- The DVD prohibits turning off subtitles.

---

**The angles cannot be changed.**

- Multi-angles are not recorded on the DVD being played (page 55).
- The DVD prohibits changing the angles.



---

**A disc cannot be ejected and “LOCKED” appears in the front panel display.**

- Contact your Sony dealer or local authorized Sony service facility.

---

**[Data error] appears on the TV screen when playing a DATA CD or DATA DVD.**

- The MP3 audio track/JPEG image file you want to play is broken.
- Data is not MPEG1 Audio Layer 3 data.
- JPEG image file format does not conform to DCF.
- A JPEG image file has the extension “.JPG” or “.JPEG,” but is not in JPEG format.

---

**The system does not work normally.**

- Disconnect the AC power cord (mains lead) from the wall outlet (mains), then reconnect after several minutes.

---

**“DEMO PLAY” appears in the front panel display.**

- Contact your Sony dealer or local authorized Sony service facility.

---

**The HDMI CONTROL function does not work.**

- When “HDMI” does not light up in the front panel display, check the HDMI connection (page 20).
- Set the [HDMI CONTROL] setting in [CUSTOM SETUP] to [ON] (page 36, 82).
- Make sure that the connected component is compatible with the HDMI CONTROL function.
- Check that the AC power cord (mains lead) of the connected component is connected securely.
- Check the connected component's setting for the HDMI CONTROL function. See the operating instructions of the component.
- If you change the HDMI connection, connect and disconnect the AC power cord (mains lead), or have a power failure, set the [HDMI CONTROL] setting in [CUSTOM SETUP] to [OFF], then set the [HDMI CONTROL] setting in [CUSTOM SETUP] to [ON] (page 36, 82).
- For details on the HDMI CONTROL function, see “Preparing for the HDMI CONTROL function” (page 36).

---

**No sound is output from the system and TV while using the System Audio Control function.**

- Set the [AUDIO (HDMI)] setting in [CUSTOM SETUP] to [AUTO] or [PCM] (page 82).
- Make sure that the connected TV is compatible with the System Audio Control function.
- For details on the System Audio Control function, see “Enjoying the TV sound from the speakers in this system” (page 39).

## Self-diagnosis Function

### (When letters/numbers appear in the display)

When the self-diagnosis function is activated to prevent the system from malfunctioning, a 5-character service number (e.g., C 13 50) with a combination of a letter and 4 digits appears on the TV screen and the front panel display. In this case, check the following table.

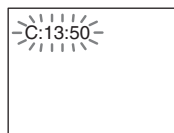

---

First 3 characters of the service number	Cause and/or corrective action
--	--------------------------------

---

C 13	The disc is dirty. ➔ Clean the disc with a soft cloth (page 85).
C 31	The disc is not inserted correctly. ➔ Restart the system, then re-insert the disc correctly.
E XX (xx is a number)	To prevent a malfunction, the system has performed the self-diagnosis function. ➔ Contact your nearest Sony dealer or local authorized Sony service facility and give the 5-character service number. Example: E 61 10

---

### When displaying the version number on the screen

When you turn on the system, the version number [VER.X.XX] (X is a number) may appear on the TV screen. Although this is not a malfunction and for Sony service use only, normal system operation will not be possible. Turn off the system, and then turn on the system again to operate.



# Specifications

## Amplifier section

### POWER OUTPUT AND TOTAL HARMONIC DISTORTION

(FTC Output Power)

for the US model

Front/Front surround: With 4 ohms loads, both channels driven, from 150 - 20,000 Hz; rated 38 watts per channel minimum RMS power, with no more than 0.7 % total harmonic distortion from 250 milli watts to rated output.

Subwoofer: With 4 ohms loads, both channels driven, from 25 - 150 Hz; rated 38 watts per channel minimum RMS power, with no more than 0.7 % total harmonic distortion from 250 milli watts to rated output.

Power output(rated)

for the Canadian model

Front/Front surround\*: 70 W + 70 W  
(at 4 ohms, 1 kHz, 1 % THD)

Subwoofer: 70 W + 70 W  
(at 4 ohms, 100 Hz, 1 % THD)

RMS output power (reference)

Front/Front surround\*: 80 W + 80 W  
(at 4 ohms, 1 kHz, 10 % THD)

Subwoofer: 80 W + 80 W  
(at 4 ohms, 100 Hz, 10 % THD)

\* Depending on the sound field settings and the source, there may be no sound output.

Inputs (Analog)

TV, SAT/CABLE, VIDEO

Sensitivity: 450 mV (ATT ON), 250 mV (ATT OFF)  
Impedance: 50 kilohms

Inputs (Digital/COAXIAL)

SAT/CABLE, VIDEO

Impedance: 75 ohms

## Video section

Outputs

VIDEO: 1 Vp-p 75 ohms

S VIDEO:

Y: 1 Vp-p 75 ohms

C: 0.286 Vp-p 75 ohms

COMPONENT:

Y: 1 Vp-p 75 ohms

P<sub>B</sub>/C<sub>B</sub>, P<sub>R</sub>/C<sub>R</sub>: 0.7 Vp-p 75 ohms

HDMI OUT: Type A (19 pin)

VIDEO: 1 Vp-p 75 ohms

Inputs

## Super Audio CD/DVD system

Laser

Semiconductor laser  
(Super Audio CD/DVD:  
 $\lambda = 650 \text{ nm}$ )  
(CD:  $\lambda = 790 \text{ nm}$ )

Emission duration:  
continuous

Signal format system

NTSC

## Tuner section

System

PLL quartz-locked digital synthesizer system

FM tuner section

Tuning range

87.5 – 108.0 MHz

Antenna (aerial)

FM wire antenna (aerial)

Antenna (aerial) terminal

75 ohms, unbalanced

Intermediate frequency

10.7 MHz

AM tuner section

Tuning range

530 – 1,710 kHz (with the interval set at 10 kHz)

531 – 1,710 kHz (with the interval set at 9 kHz)

Antenna (aerial)

AM loop antenna (aerial)

Intermediate frequency

450 kHz

## Speakers

### Front

Speaker system

Closed type, magnetically shielded

Speaker unit

25 mm (1 inch) balance drive type × 1,  
50 mm (2 inches) cone type × 2

Rated impedance

4 ohms

Dimensions (approx.)

170 × 125 × 170 mm  
(6 <sup>3</sup>/<sub>4</sub> × 5 × 6 <sup>3</sup>/<sub>4</sub> inches)  
(w/h/d)

Mass (approx.)

0.8 kg (1 lb 13 oz)

### Subwoofer

Speaker system

Bass reflex

Speaker unit

150 mm (6 inches) cone type × 2

Rated impedance

4 ohms

Dimensions (approx.)	180 × 355 × 390 mm (7 1/8 × 14 × 15 3/8 inches) (w/h/d)
Mass (approx.)	11.0 kg (24 lb 5 oz)

### General

Power requirements	120 V AC, 60 Hz
Power consumption	On: 120 W Standby: 0.3 W

Output voltage/current

#### DIGITAL MEDIA PORT:

DC 5 V/700 mA

Dimensions (approx.)	381 × 79 × 327 mm (15 × 3 1/8 × 12 7/8 inches) (w/h/d)
Mass (approx.)	6.4 kg (14 lb 2 oz)

Design and specifications are subject to change without notice.



- Standby power consumption 0.3 W.
- Halogenated flame retardants are not used in the printed wiring boards.
- Over 85 % power efficiency of amplifier block is achieved with the full digital amplifier, S-master.
- Halogenated flame retardants are not used in cabinets.

## Glossary

### Album

Section of a music piece or an image on a data CD containing MP3 audio tracks or JPEG files.

### Chapter

Subdivision of a title on a DVD. A title is composed of several chapters.

### Digital Cinema Auto Calibration

Digital Cinema Auto Calibration was developed by Sony to automatically measure and adjust the speaker settings to your listening environment in a short period of time.

### Dolby Digital

This movie theater sound format is more advanced than Dolby Surround Pro Logic. In this format, the surround speakers output stereo sound with an expanded frequency range, and a subwoofer channel for deep bass is independently provided. This format is also called “5.1” with the subwoofer channel designed as the 0.1 channel (since it functions only when a deep bass effect is needed). All six channels in this format are recorded separately for superior channel separation. Furthermore, since all the signals are processed digitally, less signal degradation occurs.

### Dolby Pro Logic II

Dolby Pro Logic II creates five full-bandwidth output channels from 2 channel sources. This is done using an advanced, high-purity matrix surround decoder that extracts the spatial properties of the original recording without adding any new sounds or tonal colorations.

### DTS

Digital audio compression technology developed by DTS, Inc. This technology conforms to 5.1-channel surround. This format comprises of stereo rear channel and there is discrete subwoofer channel in this format. DTS provides the same 5.1 discrete channels of high quality digital audio. The good channel separation is realized due to the all channel data being recorded discretely and processed in digitally.

## **DVD**

A disc that contains up to 8 hours of moving pictures even though its diameter is the same as a CD.

The data capacity of a single-layer and single-sided DVD, at 4.7 GB (Giga Byte), is 7 times that of a CD. Furthermore, the data capacity of a dual-layer and single-sided DVD is 8.5 GB, a single-layer and double-sided DVD 9.4 GB, and a dual-layer and double-sided DVD 17 GB.

The picture data uses the MPEG 2 format, one of a worldwide standard of digital compression technology. The picture data is compressed to about 1/40 of its original size. The DVD also uses the variable rate coding technology that processes allocated data according to the status of the picture.

The audio data is recorded in Dolby Digital as well as in PCM, allowing you to enjoy more realistic audio presence.

Furthermore, various advanced functions such as the multi-angle, multilingual, and Parental Control functions are provided with the DVD.

## **DVD+RW**

A DVD+RW (plus RW) is a recordable and rewritable disc. DVD+RWs use a recording format that is comparable to the DVD VIDEO format.

## **DVD-RW**

A DVD-RW is a recordable and rewritable disc that is the same size as a DVD VIDEO. The DVD-RW has two different modes: VR mode and Video mode. DVD-RWs created in Video mode have the same format as a DVD VIDEO, while discs created in VR (Video Recording) mode allow the contents to be programmed or edited.

## **File**

A JPEG image recorded on a DATA CD/DATA DVD. ("File" is an exclusive definition for this system.) A single file consists of a single image.

## **Film based software, Video based software**

DVDs can be classified as film based or Video based software. Film based DVDs contain the same images (24 frames per second) that are shown at movie theaters. Video based DVDs,

such as television dramas or sit-coms, displays images at 30 frames (or 60 fields) per second.

## **HDMI (high-definition multimedia interface)**

HDMI is an interface that supports both video and audio on a single digital connection, allowing you to enjoy high quality digital picture and sound. The HDMI specification supports HDCP (high-bandwidth digital contents protection), a copy protection technology that incorporates coding technology for digital video signals.

## **Interlace format (Interlaced scanning)**

The Interlace format is the NTSC standard method for displaying TV images at 30 frames per second. Each frame is scanned twice - alternately between the even numbered scanning lines and then odd numbered scanning lines, at 60 times per second.

## **Mica-reinforced-cellular-diaphragm**

The Mica-reinforced-cellular-diaphragm is made of a light weight and highly rigid composite material that consists of Mica flake and synthetic fiber.

It is constructed with layers of Mica flake. This construction realizes diaphragm with low density and high rigidity at the same time.

In this system, a Mica-reinforced-cellular-diaphragm is used for the subwoofer.

## **MPEG audio**

A coding system to compress digital audio signals. MPEG-1 is used for MP3 (MPEG-1 Audio Layer-3). MPEG-2 is used for one of the audio format of DVD.

## **Multi-angle function**

Various angles of a scene, or viewpoints of the video camera are recorded on some DVDs.

## **Multilingual function**

Several languages for the sound or subtitles in a picture are recorded on some DVDs.

## **Parental Control**

A DVD function to limit playback of the disc by users of a predetermined age according to the limitation level in each country. The limitation varies from disc to disc; when it is activated, playback is completely prohibited, violent

scenes are skipped or replaced with other scenes, etc.

### **PCM (Pulse Code Modulation)**

A method for converting analog audio to digital audio. It is used for the Compact Disc (CD) audio format.

### **Playback Control (PBC)**

Signals encoded on VIDEO CDs (Version 2.0) to control playback.

By using menu screens recorded on VIDEO CDs with PBC functions, you can enjoy playing simple interactive programs, programs with search functions, and so on.

### **Progressive format (sequential scanning)**

In contrast to the Interlace format, the progressive format can reproduce 50 - 60 frames per second by reproducing all scanning lines (525 lines for the NTSC system, 625 lines for the PAL system). The overall picture quality increases and still images, text and horizontal lines appear sharper. This format is compatible with the 525 or 625 progressive format.

### **Region Code**

This system is used to protect copyrights. A region number is allocated on each DVD system or DVD disc according to the sales region. Each region code is shown on the system as well as on the disc packaging. The system can play discs that match its region code. The system can also play discs with the “” mark. Even when the region code is not shown on the DVD, the region limit may still apply.

### **S-Force PRO Front Surround**

Sony’s long-term involvement in surround technology (and the vast amounts of acoustic data accumulated as a result) has led to the development of all-new processing method and advanced DSP to handle this task effectively, and which we call S-Force PRO Front Surround. Compared with previous front surround technologies, S-Force PRO Front Surround reproduces a more convincing sense of distance and space, resulting in a true surround sound experience without the need for rear speakers.

### **S-master**

S-master is an all-digital amplifier technology developed by Sony, which effectively minimizes the occurrence of sound fragmentation and jitter, delivering superb dialog clarity and faithful reproduction of the original sound. The compact amplifier section supports a higher power efficiency and improved thermal performance.

### **Scene**

On a VIDEO CD with PBC (playback control) functions, the menu screens, moving pictures and still pictures are divided into sections called “scenes.”

### **Super Audio CD**

Super Audio CD is a new high-quality audio disc standard where music is recorded in the DSD (Direct Stream Digital) format (conventional CDs are recorded in the PCM format). The DSD format, using a sampling frequency 64 times higher than that of a conventional CD, and with 1-bit quantization, achieves both a wide frequency range and a wide dynamic range across the audible frequency range, and so provides music reproduction extremely faithful to the original sound.

### **■ Types of Super Audio CDs**

There are two types of discs, depending on the Super Audio CD layer and CD layer combination.

- Super Audio CD layer: A high-density signal layer for Super Audio CD
- CD layer<sup>1)</sup>: A layer that is readable by a conventional CD player

Single layer disc  
(a disc with a single Super Audio CD layer)

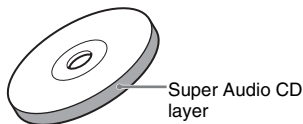

Hybrid disc<sup>2)</sup>  
(a disc with a Super Audio CD layer and a CD layer)

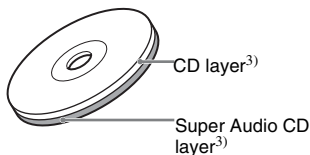

<sup>1)</sup>You can play the CD layer on a conventional CD player.

<sup>2)</sup>Since both layers are on one side, it is not necessary to turn the disc over.

<sup>3)</sup>To select a layer, see “Selecting a Playback Layer for a Super Audio CD” (page 57).

## **Title**

The longest section of a picture or music feature on a DVD, movie, etc., in video software, or the entire album in audio software.

## **Track**

Section of a picture or a music piece on a VIDEO CD, CD, Super Audio CD, or MP3. An album is composed of several tracks (MP3 only).

## **VIDEO CD**

A compact disc that contains moving pictures. The picture data uses the MPEG 1 format, one of a worldwide standard of digital compression technology. The picture data is compressed to about 1/140 of its original size. Consequently, a 12 cm VIDEO CD can contain up to 74 minutes of moving pictures.

VIDEO CDs also contain compact audio data. Sounds outside the range of human hearing are compressed while sounds we can hear are not compressed. VIDEO CDs can hold six times the audio information of conventional audio CDs. There are two versions of VIDEO CDs.

- Version 1.1: You can play only moving pictures and sounds.

- Version 2.0: You can play high-resolution still pictures and enjoy PBC functions. This system conforms to both versions.

# Language Code List

The language spellings conform to the ISO 639: 1988 (E/F) standard.

Code Language	Code Language	Code Language	Code Language
1027 Afar	1183 Irish	1347 Maori	1507 Samoan
1028 Abkhazian	1186 Scots Gaelic	1349 Macedonian	1508 Shona
1032 Afrikaans	1194 Galician	1350 Malayalam	1509 Somali
1039 Amharic	1196 Guarani	1352 Mongolian	1511 Albanian
1044 Arabic	1203 Gujarati	1353 Moldavian	1512 Serbian
1045 Assamese	1209 Hausa	1356 Marathi	1513 Siswati
1051 Aymara	1217 Hindi	1357 Malay	1514 Sesotho
1052 Azerbaijani	1226 Croatian	1358 Maltese	1515 Sundanese
1053 Bashkir	1229 Hungarian	1363 Burmese	1516 Swedish
1057 Byelorussian	1233 Armenian	1365 Nauru	1517 Swahili
1059 Bulgarian	1235 Interlingua	1369 Nepali	1521 Tamil
1060 Bihari	1239 Interlingue	1376 Dutch	1525 Telugu
1061 Bislama	1245 Inupiak	1379 Norwegian	1527 Tajik
1066 Bengali;	1248 Indonesian	1393 Occitan	1528 Thai
Bangla	1253 Icelandic	1403 (Afan)Oromo	1529 Tigrinya
1067 Tibetan	1254 Italian	1408 Oriya	1531 Turkmen
1070 Breton	1257 Hebrew	1417 Punjabi	1532 Tagalog
1079 Catalan	1261 Japanese	1428 Polish	1534 Setswana
1093 Corsican	1269 Yiddish	1435 Pashto;	1535 Tonga
1097 Czech	1283 Javanese	Pushto	1538 Turkish
1103 Welsh	1287 Georgian	1436 Portuguese	1539 Tsonga
1105 Danish	1297 Kazakh	1463 Quechua	1540 Tatar
1109 German	1298 Greenlandic	1481 Rhaeto-	1543 Twi
1130 Bhutani	1299 Cambodian	Romance	1557 Ukrainian
1142 Greek	1300 Kannada	1482 Kirundi	1564 Urdu
1144 English	1301 Korean	1483 Romanian	1572 Uzbek
1145 Esperanto	1305 Kashmiri	1489 Russian	1581 Vietnamese
1149 Spanish	1307 Kurdish	1491 Kinyarwanda	1587 Volapük
1150 Estonian	1311 Kirghiz	1495 Sanskrit	1613 Wolof
1151 Basque	1313 Latin	1498 Sindhi	1632 Xhosa
1157 Persian	1326 Lingala	1501 Sangho	1665 Yoruba
1165 Finnish	1327 Laothian	1502 Serbo-	1684 Chinese
1166 Fiji	1332 Lithuanian	Croatian	1697 Zulu
1171 Faroese	1334 Latvian;	1503 Singhalese	
1174 French	Lettish	1505 Slovak	
1181 Frisian	1345 Malagasy	1506 Slovenian	1703 Not specified

Additional Information

## Parental Control Area Code List

Code Area	Code Area	Code Area	Code Area
2044 Argentina	2165 Finland	2362 Mexico	2149 Spain
2047 Australia	2174 France	2376 Netherlands	2499 Sweden
2046 Austria	2109 Germany	2390 New Zealand	2086 Switzerland
2057 Belgium	2248 India	2379 Norway	2528 Thailand
2070 Brazil	2238 Indonesia	2427 Pakistan	2184 United Kingdom
2079 Canada	2254 Italy	2424 Philippines	
2090 Chile	2276 Japan	2436 Portugal	
2092 China	2304 Korea	2489 Russia	
2115 Denmark	2363 Malaysia	2501 Singapore	

# Index to Parts and Controls



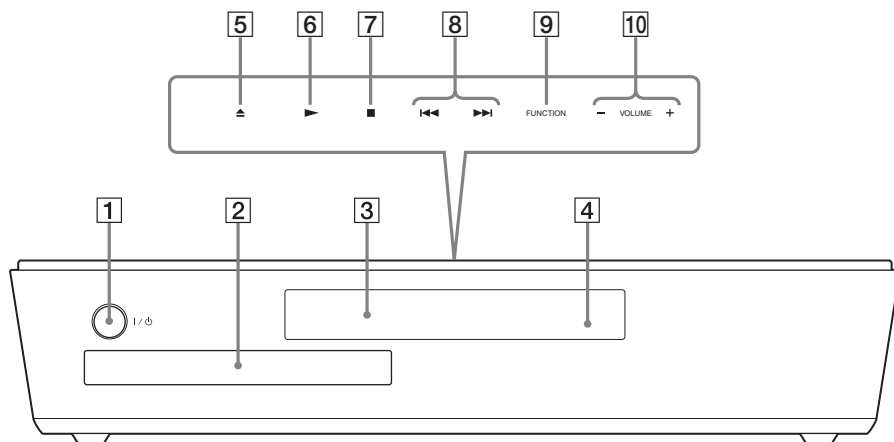

For more information, refer to the pages indicated in parentheses.

## Front panel



- 1 I/O (on/standby) (28)
- 2 Disc tray (28)
- 3 Front Panel Display
- 4  (remote sensor) (9)

### Soft-touch buttons (28, 70)

- 5  (open/close) (28)
- 6  (play) (28)
- 7  (stop) (28)
- 8  (prev/next) (28)
- 9 FUNCTION (28)
- 10 VOLUME -/+ (28)



## Rear panel

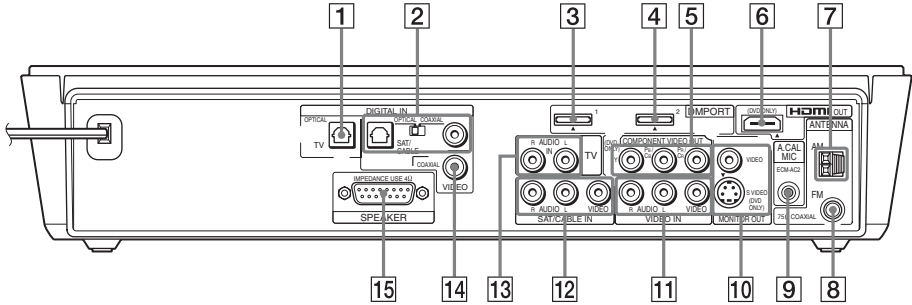

- |   |  |
|---|--|
| <p><b>1</b> TV (DIGITAL IN OPTICAL) jack (20)</p> <p><b>2</b> SAT/CABLE (DIGITAL IN COAXIAL/OPTICAL) jacks (25)</p> <p><b>3</b> DMPORT1 jack (25, 71)</p> <p><b>4</b> DMPORT2 jack (25, 71)</p> <p><b>5</b> COMPONENT VIDEO OUT jacks (20)</p> <p><b>6</b> HDMI OUT jack (20)</p> <p><b>7</b> AM terminal (10)</p> <p><b>8</b> FM 75Ω COAXIAL jack (10)</p> <p><b>9</b> A.CAL MIC jack (18, 75)</p> | <p><b>10</b> MONITOR OUT (S VIDEO/VIDEO) jacks (20)</p> <p><b>11</b> VIDEO IN (AUDIO IN L/R, VIDEO IN) jacks (25)</p> <p><b>12</b> SAT/CABLE IN (AUDIO IN L/R, VIDEO IN) jacks (25)</p> <p><b>13</b> TV (AUDIO IN L/R) jacks (10)</p> <p><b>14</b> VIDEO (DIGITAL IN COAXIAL) jack (25)</p> <p><b>15</b> SPEAKER jack (10)</p> |
|---|--|

## Front panel display

### About the indications in the front panel display

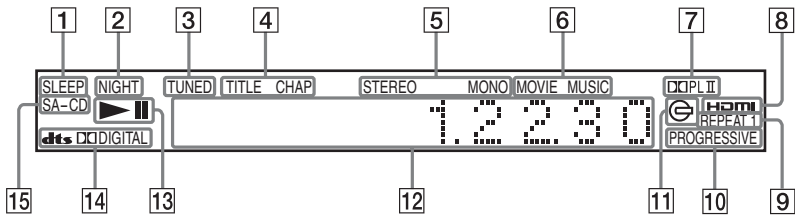

- 1 Lights up when the sleep timer is set. (69)
- 2 Lights up when the night mode is on. (34)
- 3 Lights up when a station is received. (Radio only) (64)
- 4 Lights up when the time information of a title or chapter appears in the front panel display. (DVD only) (53)
- 5 Stereo/Monaural effect (Radio only) (65)
- 6 Lights up when the movie or music mode is selected. (31)
- 7 Current surround format (Except for JPEG and Super Audio CD)
- 8 Lights up when the HDMI OUT jack is correctly connected to HDCP (high-bandwidth digital content protection) compliant device with HDMI or DVI (digital visual interface) input. (20)
- 9 Current repeat mode (49)
- 10 Lights up when the system outputs progressive signals (DVD function only). (23)
- 11 Lights up when a disc is loaded (DVD function only).
- 12 Displays system's status such as chapter, title, or track number, time information, radio frequency, playing status, sound field, etc.
- 13 Playing status (DVD function only)
- 14 Current surround format (Except for JPEG and Super Audio CD)
- 15 Lights up when a Super Audio CD/CD/ DATA CD is loaded.

## Remote control

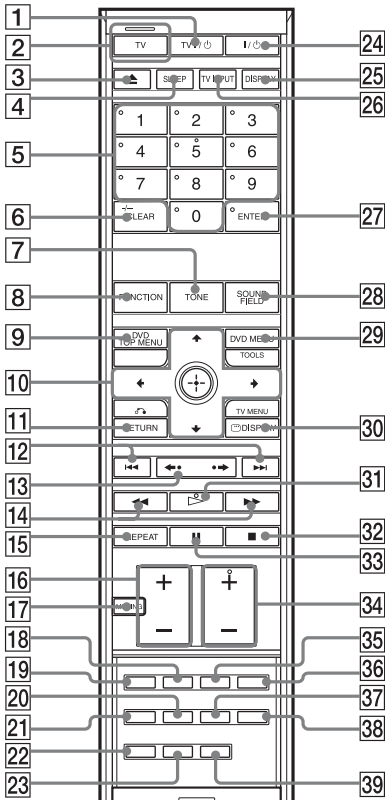

- 1 TV I/⏻ (on/standby) (68)
- 2 TV button/TV mode indicator (68)
- 3 ▲ (OPEN/CLOSE) (28)
- 4 SLEEP (69)
- 5 Number buttons<sup>2) 3)</sup> (44, 50, 63, 65, 68, 72)
- 6 CLEAR (44, 65)  
-/-<sup>3)</sup> (68)
- 7 TONE (33)
- 8 FUNCTION (28, 64, 75)
- 9 DVD TOP MENU (50)
- 10 ◀/▶/↶/↷, ⊕ (ENTER)<sup>3)</sup> (18, 30, 36, 44, 64, 68, 72)
- 11 ↶ ↷ RETURN<sup>3)</sup> (45, 68)
- 12 ◀◀/▶▶ (28)  
PRESET -/+ (65)

- 13 ◀◀/▶▶ (28)  
◀◀/▶▶ STEP (43)
- 14 ◀◀/▶▶ (43)  
◀◀/▶▶ (43)  
TUNING -/+ (64)
- 15 REPEAT (49)
- 16 VOLUME +/-<sup>3)</sup> (28, 65, 68)
- 17 MUTING (28)
- 18 AUDIO<sup>2)</sup> (51, 69)
- 19 PICTURE NAVI (45)
- 20 MOVIE/MUSIC (31)
- 21 RESOLUTION (23)
- 22 DIRECT TUNING (65)
- 23 TUNER MENU (64)
- 24 I/⏻ (on/standby) (18, 28, 46, 65)
- 25 DISPLAY (53)
- 26 TV INPUT (68)
- 27 ENTER<sup>1) 3)</sup> (18, 30, 36, 44, 64, 68, 72)
- 28 SOUND FIELD (31, 32)
- 29 DVD MENU (50)  
TOOLS<sup>3)</sup> (68)
- 30 ⊕ DISPLAY (19, 36, 44, 72, 100)  
TV MENU<sup>3)</sup> (68)
- 31 ▷ (play)<sup>2)</sup> (28, 46)
- 32 ■ (stop) (29, 46, 72)
- 33 || (pause) (29)
- 34 TV CH +/-<sup>2)</sup> (68)
- 35 SUBTITLE (56)
- 36 ANGLE (55)
- 37 NIGHT (34)
- 38 DIMMER (70)
- 39 SYSTEM MENU (30, 53, 56, 57, 70, 77, 104)

<sup>1)</sup> The ENTER **27** button is the same function as the ⊕ (ENTER) **10** button.

<sup>2)</sup> The 5, ▷, and TV CH +, and AUDIO buttons have tactile dots. Use the tactile dots as references when operating the system.

<sup>3)</sup> These buttons change to the TV operation buttons when the remote is in TV mode. The remote is in TV mode when the TV mode indicator **2** lights up by pressing the TV button **2**.

# Guide to the Control Menu Display

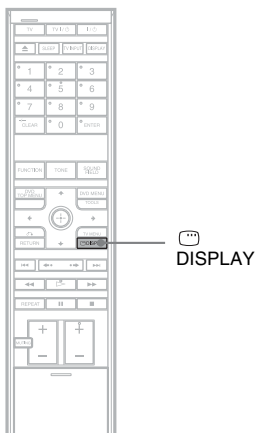

Use the Control Menu display to select a function and to view related information. Press DISPLAY repeatedly to turn on or change the Control Menu display as follows:

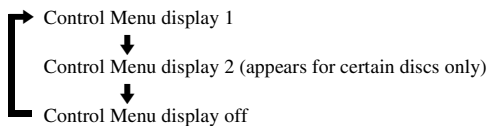

---

## Control Menu display

The Control Menu display 1 and 2 will show different items depending on the disc type. For details about each item, see the pages in parentheses.

Example: Control Menu display 1 when playing a DVD VIDEO.

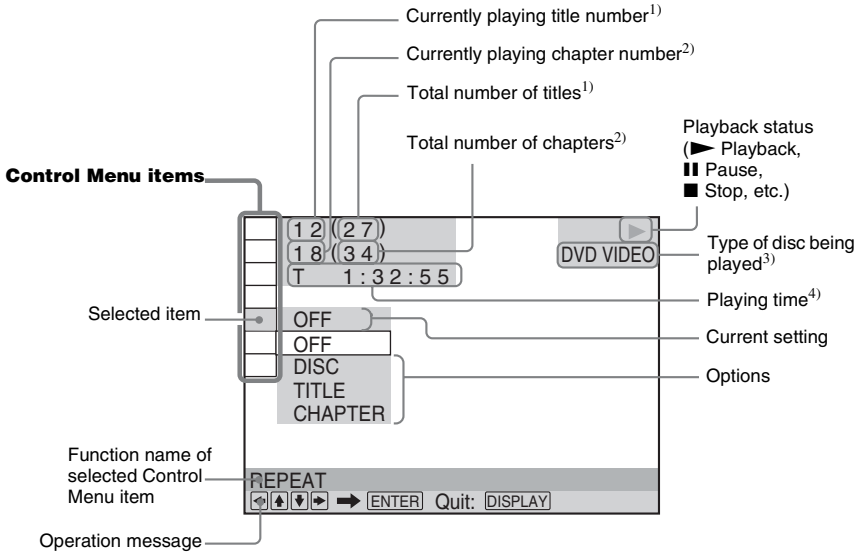

<sup>1)</sup>Displays the scene number for VIDEO CDs (PBC is on), track number for VIDEO CDs/Super Audio CDs/CDs, album number for DATA CDs/DATA DVDs.

<sup>2)</sup>Displays the index number for VIDEO CDs/Super Audio CDs, MP3 audio track number, or JPEG image file number for DATA CDs/DATA DVDs.

<sup>3)</sup>Displays Super VCD as "SVCD." Displays "MP3" in the Control Menu display 1 or "JPEG" in the Control Menu display 2 for DATA CDs/DATA DVDs.













<sup>4)</sup>Displays the date for JPEG files.

## To turn off the display

Press DISPLAY.

## List of Control Menu items

Item	Item Name, Function, Relevant Disc Type
	<b>[TITLE] (page 44)/[SCENE] (page 44)/[TRACK] (page 44)</b> Selects the title, scene, or track to be played. <span style="float: right;">DVD-V DVD-VR VIDEO CD</span>
	<b>[CHAPTER] (page 44)/[INDEX] (page 44)</b> Selects the chapter or index to be played. <span style="float: right;">DVD-V DVD-VR VIDEO CD</span>
	<b>[INDEX] (page 44)</b> Displays the index and selects the index to be played. <span style="float: right;">Super Audio CD</span>
	<b>[TRACK] (page 44)</b> Selects the track to be played. <span style="float: right;">CD DATA-CD DATA DVD Super Audio CD</span>
	<b>[ORIGINAL/PLAY LIST] (page 52)</b> Selects the type of titles (DVD-R/DVD-RW) to be played, the [ORIGINAL] one, or an edited [PLAY LIST]. <span style="float: right;">DVD-VR</span>

	<p><b>[TIME/TEXT] (page 44)</b>  Checks the elapsed time and the remaining playback time.  Input the time code for picture and music searching.  Displays the DVD/CD text or the MP3 track name.</p> <p style="text-align: right;">DVD-V DVD-VR VIDEO CD CD DATA-CD DATA DVD Super Audio CD</p>
	<p><b>[AUTO CALIBRATION] (page 75)</b>  Adjust the level of each speaker automatically.</p> <p style="text-align: right;">DVD-V DVD-VR VIDEO CD CD DATA-CD DATA DVD Super Audio CD</p>
	<p><b>[PROGRAM] (page 47)</b>  Selects the track to play in the order you want.</p> <p style="text-align: right;">VIDEO CD CD Super Audio CD</p>
	<p><b>[SHUFFLE] (page 48)</b>  Plays the track in random order.</p> <p style="text-align: right;">VIDEO CD CD DATA-CD DATA DVD Super Audio CD</p>
	<p><b>[REPEAT] (page 49)</b>  Plays the entire disc (all titles/all tracks/all albums) repeatedly or one title/chapter/track/album repeatedly.</p> <p style="text-align: right;">DVD-V DVD-VR VIDEO CD CD DATA-CD DATA DVD Super Audio CD</p>
	<p><b>[PARENTAL CONTROL] (page 72)</b>  Sets to prohibit playback on this system.</p> <p style="text-align: right;">DVD-V DVD-VR VIDEO CD CD DATA-CD DATA DVD Super Audio CD</p>
	<p><b>[SETUP] (page 78)</b>  [QUICK] Setup (page 18)  Use Quick Setup to choose the desired language of the on-screen display, the aspect ratio of the TV, choose [YES] or [NO] to start the [AUTO CALIBRATION].  [CUSTOM] Setup  In addition to the Quick Setup setting, you can adjust various other settings.  [RESET]  Returns the settings in [SETUP] to the default setting.</p> <p style="text-align: right;">DVD-V DVD-VR VIDEO CD CD DATA-CD DATA DVD Super Audio CD</p>
	<p><b>[ALBUM] (page 44)</b>  Selects the album to be played.</p> <p style="text-align: right;">DATA-CD DATA DVD</p>
	<p><b>[FILE] (page 44)</b>  Selects the JPEG image file to be played.</p> <p style="text-align: right;">DATA-CD DATA DVD</p>
	<p><b>[DATE] (page 55)</b>  Displays the date the picture was taken by a digital camera.</p> <p style="text-align: right;">DATA-CD DATA DVD</p>
	<p><b>[INTERVAL] (page 61)</b>  Specifies the duration for which the slides are displayed on the screen.</p> <p style="text-align: right;">DATA-CD DATA DVD</p>
	<p><b>[EFFECT] (page 61)</b>  Selects the effects to be used for changing slides during a slide show.</p> <p style="text-align: right;">DATA-CD DATA DVD</p>
	<p><b>[MODE (MP3, JPEG)] (page 61)</b>  Selects the data type; MP3 audio track (AUDIO), JPEG image file (IMAGE) or both (AUTO) to be played when playing a DATA CD/DATA DVD.</p> <p style="text-align: right;">DATA-CD DATA DVD</p>

**Tip**

- The Control Menu icon indicator lights up in green  →  when you select any item except [OFF] ([PROGRAM], [SHUFFLE], and [REPEAT] only). The [ORIGINAL/PLAY LIST] indicator lights up in green when you select [PLAY LIST] (default setting).

# DVD Setup Display List

You can set the following items with the DVD Setup Display.

The order of the displayed items may be different from the actual display.

The default settings are underlined.

## LANGUAGE SETUP

- OSD\*
- MENU\*
- AUDIO\*
- SUBTITLE\*

## SCREEN SETUP

- TV TYPE — 16:9
  - 4:3 LETTER BOX
  - 4:3 PAN SCAN
- HDMI — AUTO
  - RESOLUTION — 1920 × 1080i
    - 1280 × 720p
    - 720 × 480p
- YC<sub>B</sub>C<sub>R</sub>/RGB (HDMI) — YC<sub>B</sub>C<sub>R</sub>
  - RGB
- SCREEN SAVER — ON
  - OFF
- BACKGROUND — JACKET
  - PICTURE
  - GRAPHICS
  - BLUE
  - BLACK
- BLACK LEVEL — ON
  - OFF
- BLACK LEVEL (COMPONENT OUT) — OFF
  - ON
- 4:3 OUTPUT — FULL
  - NORMAL

## CUSTOM SETUP

- HDMI — OFF
  - CONTROL — ON
- STB — OFF
  - SYNCHRO — ON
- PAUSE — AUTO
  - MODE — FRAME
- TRACK — OFF
  - SELECTION — AUTO
- MULTI-DISC — ON
  - RESUME — OFF
- AUDIO DRC — OFF
  - STANDARD
  - MAX
- AUDIO (HDMI) — OFF
  - AUTO
  - PCM

\* Select the language you want to use from the displayed language list.

## System Menu List

You can set the following items with SYSTEM MENU on the remote.

### System menu

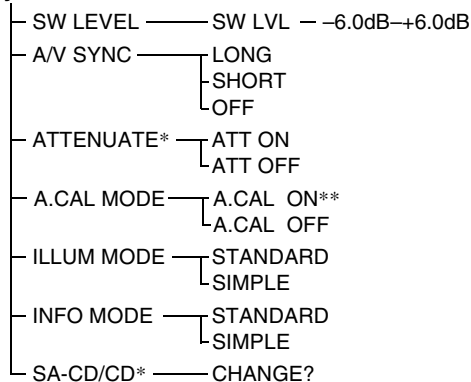

\* “ATTENUATE” and “SA-CD/CD” may not appear, depending on the selected function.

\*\* If “Setup A.CAL” appears in the front panel display, perform [AUTO CALIBRATION]. For details, see page 75.

## Tuner Menu List

You can set the following items with TUNER MENU on the remote.

### Tuner menu

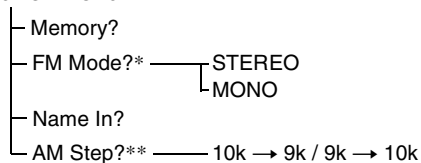

\* “FM Mode?” appears only when the function is set to “FM.”

\*\*\* “AM Step?” appears only when the function is set to “AM.”



# Index

## Numerics

- 16:9 80
- 4:3 LETTER BOX 80
- 4:3 OUTPUT 81
- 4:3 PAN SCAN 80
- 5.1 Channel Surround 52

## A

- A.CAL MODE 77
- A/V SYNC 56
- ALBUM 44
  - Album 91
- AM Step 64
- ANGLE 55
- ATTENUATE 30
- AUDIO 79
- AUDIO (HDMI) 83
- AUDIO DRC 83
- Auto Calibration 75, 91

## B

- BACKGROUND 81
- BASS 33
- Batteries 9
- BLACK LEVEL 81
- BLACK LEVEL (COMPONENT OUT) 81

## C

- CHAPTER 44
  - Chapter 91
- COAXIAL (Digital Out) 26
- COMPONENT VIDEO OUT 23
  - Continuous play 28
  - Control Menu Display 100
  - Controlling the TV 67
- CUSTOM 78
- CUSTOM PARENTAL CONTROL 72
- CUSTOM SETUP 82

## D

- DATA CD 59
- DATA DVD 59
- Digital Cinema Auto Calibration 75, 91
- DIGITAL MEDIA PORT 71
- DIMMER 70
- DISPLAY 66
- Dolby Digital 51, 91

- Dolby Pro Logic II 91
- DTS 51, 91
- DUAL MONO 69
- DVD 92
- DVD+RW 92
- DVD's menu 50
- DVD-RW 52, 92
- DVI 22

## E

- EFFECT 62

## F

- Fast forward 43
- Fast reverse 43
- FILE 44
- File 92
- Film based software 92
- FM Mode 65
- Freeze Frame 43
- Front panel 96
- Front panel display 53, 98

## H

- Handling discs 85
- HDMI
  - HDMI RESOLUTION 80
  - YCbCr/RGB (HDMI) 80
- HDMI (high-definition multimedia interface) 21, 92
- HDMI CONTROL 36, 82

## I

- ILLUMINATION MODE 70
- INDEX 44
- INFORMATION MODE 53
- Instant advance 29
- Instant replay 29
- INTERLACE 24
- Interlace format 92
- INTERVAL 61

## J

- JPEG 57, 59

## L

- Language Code List 95
- LANGUAGE SETUP 79
- Listening
  - other components 30
  - TV sound 31

## M

- Memory Clear 83
- MENU 79
- Mica-reinforced-cellular-diaphragm 92
- MODE (MP3, JPEG) 61
- MOVIE/MUSIC 31
- MP3 57, 59
- MPEG audio 92
- Multi Session CD 7
- Multi-angle function 55, 92
- MULTI-DISC RESUME 82
- Multilingual function 92
- Multiplex broadcast sound 69
- MUTING 29

## N

- Naming preset stations 65
- NIGHT 34
- NIGHT MODE 34

## O

- OPTICAL (Digital Out) 26
- ORIGINAL 52
- OSD 79
- Other Component Hookup 25

## P

- PARENTAL CONTROL 73
- Parental Control 92
- PAUSE MODE 82
- PBC Playback 63
- PCM (Pulse Code Modulation) 93
- PICTURE NAVI 45, 60
- PLAY LIST 52
- Playback Control (PBC) 93
- Program Play 47
- PROGRESSIVE AUTO 23
- Progressive format 23, 93
- PROGRESSIVE VIDEO 24

## Q

- Quick Setup 18

## R

- Radio 65
- Radio Stations 64
- Rear Panel 97
- Region Code 8, 93
- Remote 9, 67, 99

*continued*

Repeat Play 49  
RESET 79  
Resume Play 46

## **S**

S VIDEO 21  
Scan 43  
SCENE 44  
Scene 93  
SCREEN SAVER 81  
SCREEN SETUP 80  
Searching for a particular point  
on a disc 43  
Selecting 31  
SETUP 78  
S-Force PRO Front Surround  
32, 93  
Shuffle Play 48  
SLEEP 69  
Slide Show 61  
Slow-motion Play 43  
S-master 93  
Soft-touch buttons 28  
Sound Field 32  
STB SYNCHRO 82  
SUBTITLE 56, 79  
Subwoofer level 77  
Super Audio CD 57, 93  
Supplied items 9  
SYSTEM MENU 30, 53, 56,  
57, 70, 77  
System menu list 104

## **T**

TIME/TEXT 44  
TITLE 44  
Title 94  
TONE 33  
TRACK 44  
Track 94  
TRACK SELECTION 82  
TREBLE 33  
Troubleshooting 86  
Tuner menu list 104  
TV Hookup 20  
TV TYPE 80

## **U**

Usable discs 6

## **V**

Video based software 92  
VIDEO CD 94

